



***RapidScan3D***  
***Ultrasonic Instrumentation***

***User Guide & Reference Manual***

Part Number: 147364

---

# Table of Contents

<b>1. GENERAL INFORMATION</b>	<b>1</b>
1.1. WARRANTY	1
1.2. EQUIPMENT DIRECTIVE CONFORMANCE	2
1.3. RISKS AND HAZARDS	3
1.4. OPERATING CONDITIONS	3
1.5. EQUIPMENT TERMINAL RATINGS	3
1.5.1. Mains supply	3
1.5.2. Encoder Inputs	3
1.5.3. External Devices Connection	3
1.6. EQUIPMENT INSTALLATION	3
1.6.1. Assembly Location and Mounting Requirements	3
1.6.2. Protective Earth and Connection to Supply	3
1.7. OPERATOR REQUIREMENTS	4
1.8. MAINTENANCE REQUIREMENTS	5
1.9. SERVICE PROCEDURE	6
<b>2. SYSTEM DESCRIPTION</b>	<b>7</b>
2.1. OVERVIEW	7
2.2. SPECIFICATIONS	8
2.2.1. Ultrasonic Array	8
2.2.2. Ultrasonic Electronics	8
2.2.3. Processing Electronics	8
2.2.4. Scan Velocity	9
2.2.5. External Dimensions of Instrument	9
<b>3. SYSTEM CONCEPTS</b>	<b>10</b>
3.1. CONVENTIONS	10
3.2. SCAN	11
3.3. B-SCAN	11
3.4. GATES	12
3.5. C-SCAN	12
3.6. ULTRASONIC ARRAY TRANSDUCERS	13
3.7. COUPLING THE WHEEL PROBE	14
3.8. TIME CORRECTED GAIN (TCG)	15
3.9. T-SCAN	17
<b>4. USING RAPIDSCAN FOR THE FIRST TIME</b>	<b>18</b>
4.1. EQUIPMENT CHECKLIST	18
4.1.1. Optional Add-Ons	19
4.2. CONNECTING RAPIDSCAN COMPONENTS	20
4.2.1. Connecting Power to the Instrument	20
4.2.2. Connecting the Wheel Probe	21

---

4.2.3.	<i>Connecting the Laptop</i> .....	22
4.3.	INSTALLING SOFTWARE ON THE RAPIDSCAN LAPTOP .....	23
4.3.1.	<i>The Setup CD</i> .....	23
4.3.2.	<i>Special Notes Regarding the Operating System</i> .....	23
4.3.3.	<i>Starting RapidScan</i> .....	24
4.4.	LOGGING ON (OPTIONAL).....	25
4.5.	NAVIGATING THE RAPIDSCAN MENU SYSTEM .....	26
4.5.1.	<i>Navigating a C-Scan Session</i> .....	27
4.5.2.	<i>Navigating a T-Scan session</i> .....	31
<b>5.</b>	<b>OBTAINING A C-SCAN USING RAPIDSCAN</b> .....	<b>33</b>
5.1.	CONFIGURING FUNDAMENTAL SETTINGS .....	33
5.1.1.	<i>Array Aperture</i> .....	34
5.1.2.	<i>Automatic Velocity Selection</i> .....	34
5.1.3.	<i>Normalising the Array</i> .....	35
5.1.4.	<i>Automatic Encoder Calibration</i> .....	37
5.2.	ESTABLISHING AN A-SCAN .....	39
5.3.	IMPLEMENTING TCG .....	42
5.3.1.	<i>Applying a Logarithmic TCG Curve</i> .....	42
5.3.2.	<i>Applying a Custom TCG Curve</i> .....	43
5.3.3.	<i>Converting a Logarithmic Curve to a Custom Curve</i> .....	43
5.3.4.	<i>Delaying TCG Using the Interface Gate</i> .....	43
5.4.	SETTING UP GATES FOR A BASIC C-SCAN .....	45
5.4.1.	<i>Gates Sub-Menu 1</i> .....	45
5.4.2.	<i>Mouse Actions</i> .....	46
5.4.3.	<i>Configuring Gates</i> .....	47
5.4.4.	<i>Configuring Measurement Gates</i> .....	47
5.4.5.	<i>Software Gating</i> .....	50
5.4.6.	<i>Gates Sub-Menu 2: Variable Width Gates</i> .....	50
5.5.	ADJUSTING THE B-SCAN .....	52
5.5.1.	<i>B-Scan Synchronisation</i> .....	53
5.6.	PERFORMING A C-SCAN.....	55
5.6.1.	<i>C-Scan Views</i> .....	57
5.6.2.	<i>Capturing a C-Scan</i> .....	58
5.6.3.	<i>Saving a C-Scan</i> .....	59
5.6.4.	<i>Using the Wheel Probe Start/Stop Button</i> .....	60
5.6.5.	<i>C-Scan Mouse Actions</i> .....	61
5.7.	APPLYING & EDITING THE COLOUR MAP.....	61
5.7.1.	<i>Applying the Colour Map</i> .....	61
5.7.2.	<i>Editing the Colour Map</i> .....	63
5.8.	DRAG-ABLE COLOUR BAR .....	70
5.9.	MARKING THE DEFECTS .....	73
5.9.1.	<i>Basic Behaviour of Defect Objects</i> .....	73
5.9.2.	<i>Evaluation Sub-Menu 1</i> .....	74
5.9.3.	<i>Evaluation Sub-Menu 2</i> .....	77

---

---

5.10.	STORING AND PRINTING USING THE SETTINGS SUB-MENU 1 .....	79
5.10.1.	<i>Importing and Exporting Data</i> .....	80
5.11.	DOWNLOADING DATA FROM THE RAPIDSCAN .....	83
<b>6.</b>	<b>CREATING A T-SCAN USING RAPIDSCAN .....</b>	<b>84</b>
6.1.	CONFIGURING FUNDAMENTAL T-SCAN PARAMETERS.....	84
6.1.1.	<i>T-Scan Sub-Menu 1</i> .....	84
6.1.2.	<i>T-Scan Sub-Menu 2</i> .....	86
6.1.3.	<i>T-scan Keyboard Shortcuts</i> .....	88
6.1.4.	<i>Moving C-scan Positions</i> .....	88
6.2.	COMMON BEHAVIOUR BETWEEN C-SCAN AND T-SCAN MODES .....	89
6.2.1.	<i>Extracting A-Scan Data from the T-Scan</i> .....	89
6.2.2.	<i>Applying the Colour Map</i> .....	89
6.2.3.	<i>Editing the Colour Map</i> .....	90
6.2.4.	<i>Marking the Defects</i> .....	90
6.2.5.	<i>Importing and Exporting Data</i> .....	90
6.2.6.	<i>Printing Scans and Settings</i> .....	90
6.2.7.	<i>Changing the Coordinate Origin</i> .....	90
6.3.	RE-GATING THE T-SCAN.....	91
<b>7.</b>	<b>WORKFLOW TOOLS AND THREE-DIMENSIONAL SCANNING AND EVALUATION</b>	<b>93</b>
7.1.	INSPECTION REPOSITORY.....	93
7.2.	INSPECTION DIALOG.....	94
7.2.1.	<i>Inspection Sub-Menu 1</i> .....	94
7.2.2.	<i>Parts, Scans and Tools</i> .....	95
7.2.3.	<i>Operator Workflow for Selecting and Starting a Scan</i> .....	96
7.2.4.	<i>Inspection Sub-Menu 2</i> .....	96
7.2.5.	<i>Special Gates</i> .....	97
7.2.6.	<i>Workflow for Updating Ultrasonic Settings for a Tool</i> .....	98
7.2.7.	<i>Workflow for Calibrating the Position of a Part</i> .....	98
7.2.8.	<i>Workflow for Testing the Part Calibration</i> .....	100
7.2.9.	<i>Workflow for Deleting an Inspection from the Repository</i> .....	101
7.2.10.	<i>Workflow for Adding a Tool to an Inspection</i> .....	101
7.3.	INSPECTION GENERATION .....	102
7.4.	GENERATE DIALOG .....	102
7.4.1.	<i>Generate Menu</i> .....	102
7.4.2.	<i>Workflow for Testing FaroArm</i> .....	103
7.4.3.	<i>Workflow for Calculating FaroArm Zero-Angle</i> .....	103
7.5.	INTRODUCTION TO STOCK-OBJECTS SHAPE GENERATION.....	105
7.6.	STOCK-OBJECT CALIBRATION.....	106
7.6.1.	<i>Plane Stock-Shape</i> .....	106
7.6.2.	<i>Cylinder-Section Stock-Shape</i> .....	107
7.6.3.	<i>Full Cylinder Stock-Shape</i> .....	107
7.6.4.	<i>Spherical-Arc Stock-Shape</i> .....	108

---



---

7.6.5.	<i>Workflow for Generating a New Inspection</i> .....	108
7.6.6.	<i>Stock-Object Information</i> .....	109
7.6.7.	<i>Testing Stock-Shape Part Calibration</i> .....	112
7.7.	MANIPULATING 3-DIMENSIONAL VISUALISATION.....	115
7.7.1.	<i>Basic Mouse-Gesture Reference</i> .....	115
7.7.2.	<i>Translating 3-Dimensional View</i> .....	115
7.7.3.	<i>Rotating 3-Dimensional View</i> .....	116
7.7.4.	<i>Zooming 3-Dimensional View</i> .....	119
7.7.5.	<i>Quick Inspection in 3-Dimensional View</i> .....	120
7.7.6.	<i>Quick Reset of 3-Dimensional View</i> .....	121
7.8.	SCANNING IN 3-DIMENSIONS .....	122
7.9.	EVALUATING ULTRASONIC DATA IN 3-DIMENSIONS .....	124
7.9.1.	<i>Using the Mouse</i> .....	124
7.9.2.	<i>Using the FaroArm</i> .....	126
<b>8.</b>	<b>WORKED EXAMPLES .....</b>	<b>127</b>
8.1.	GENERAL METHOD .....	127
8.2.	THICKNESS MAPPING (CORROSION) .....	127
8.3.	DELAMINATION DETECTION.....	129
8.4.	POROSITY INSPECTION.....	132
8.5.	BOND INSPECTION .....	139
<b>9.</b>	<b>KEYBOARD AND MOUSE SHORTCUTS .....</b>	<b>145</b>
9.1.	KEYBOARD SHORTCUTS.....	145
9.2.	MOUSE SHORTCUTS FOR C OR T-SCAN.....	145
9.3.	KEYBOARD SHORTCUTS FOR T-SCAN ONLY .....	145
9.4.	MOUSE SHORTCUTS FOR T-SCAN ONLY .....	145
<b>APPENDICES</b> .....	<b>147</b>	
HUD GLASSES/EXTERNAL MONITOR SUPPORT .....	147	
<i>Activating Secondary Display</i> .....	147	
<i>Using Secondary Display</i> .....	148	
<i>Deactivating Secondary Display</i> .....	149	

---

## List of Figures

Figure 1: Wheel Probe Bung Locations.....	5
Figure 2: The RapidScan Instrument.....	7
Figure 3: Axial Convention for RapidScan.....	10
Figure 4: A-Scan Convention.....	11
Figure 5: B-Scan Convention.....	12
Figure 6: C-Scan Convention.....	13
Figure 7: Huygen's Principle.....	13
Figure 8: Model of Beam Formed by 8 Elements.....	14
Figure 9: Water Coupling around a Raised Feature.....	15
Figure 10: A-Scan of Structure with No TCG Applied.....	16
Figure 11: A-Scan of Structure with Log TCG Applied.....	16
Figure 12: A-Scan of Structure with Custom TCG Applied.....	17
Figure 13: RapidScan Power Cable Connector.....	20
Figure 14: RapidScan Wheel Probe Connector.....	21
Figure 15: RapidScan Position Encoder Connector.....	22
Figure 16: Starting RapidScan from the Start Menu.....	24
Figure 17: The Logon Screen.....	25
Figure 18: RapidScan Start-up Screen.....	26
Figure 19: C-Scan Session Top Button Strip.....	27
Figure 20: A View and B-A View.....	28
Figure 21: C View and A-B-C View.....	29
Figure 22: A-C-B View and C-C-C View.....	29
Figure 23: C-C-C-C View and C-C-A View.....	29
Figure 24: C-Scan Setting Menu.....	30
Figure 25: An Example RadioButtons Control.....	30
Figure 26: An Example Text-Dial-Arrows Control.....	30
Figure 27: T-Scan Session Top Button Strip.....	31
Figure 28: T View (left) and A-B-T View (right).....	32
Figure 29: The Settings Menu.....	33
Figure 30: The Normalisation Menu.....	35
Figure 31: The A-Scan menu.....	39
Figure 32: The A-Scan View and Menu.....	40
Figure 33: Logarithmic TCG Mode Menu.....	42
Figure 34: Custom TCG Mode Menu.....	43
Figure 35: Gates Menu 1.....	45
Figure 36: Example of Correct Interface Gate Configuration.....	47
Figure 37: Level and Edge Triggering.....	48
Figure 38: Menu 2: Variable Width Gates.....	51
Figure 39: The B-Scan Menu.....	52
Figure 40: No B-Scan Synchronisation Active.....	53
Figure 41: B-Scan Synchronisation Activated.....	54

---

Figure 42: The Sub-Menu 1 of C-Scan Menu .....	55
Figure 43: C-scan image effect after stretch and fit .....	57
Figure 44: C-C-A View .....	58
Figure 45: Going Over a C-Scan to Remove Mis-triggers.....	59
Figure 46: Saving a C-Scan.....	60
Figure 47: The Colour Map Sub-Menu 1.....	61
Figure 48: The Colour Map Editor.....	63
Figure 49: A Solid and a Smooth Block.....	64
Figure 50: An Example of 10 Blocks.....	65
Figure 51: The C. Map Edit Menu.....	66
Figure 52: HSV Colour Space as a Cone.....	68
Figure 53: Selecting a Colour in the Colour-Map Editor.....	68
Figure 54: Adjusting the Boundary Between two Blocks.....	69
Figure 55: Moving a Block.....	69
Figure 56: Original C-Scan Colour-Map.....	70
Figure 57: Effect of Dragging Colour-Bar Downwards.....	71
Figure 58: Effect of Dragging Colour-Bar Upwards.....	71
Figure 59: Evaluation Tools Sub-Menu 1.....	74
Figure 60: Example of Five Types of Defect Objects.....	75
Figure 61: Evaluation Tools Sub-Menu 2.....	77
Figure 62: The Settings Sub-Menu 1.....	79
Figure 63: Loading a File to Start an Off-line Session.....	80
Figure 64: Importing Data into an Online Session.....	81
Figure 65: Result of Ctrl-I Save of C-Scan Bitmap Image.....	82
Figure 66: Result of Ctrl-Shift-I Save of C-Scan Bitmap Image.....	82
Figure 67: T-Scan Sub-Menu 1.....	84
Figure 68: T-Scan Sub-Menu 2.....	87
Figure 69: A-T-B View Selected.....	89
Figure 70: Example of A and B-Scan Extraction from T-Scan.....	89
Figure 71: Selecting T-Scan Colour Map.....	89
Figure 72: Gating Choices when Saving a T-Scan.....	92
Figure 73: Inspection Selection View.....	93
Figure 74: The Inspection Sub-Menu 1.....	94
Figure 75: Inspection Sub-Menu 2.....	96
Figure 76: Selecting Calibration Point One of 3-Dimensional CAD Data.....	99
Figure 77: Selecting Calibration Point Two of 3-Dimensional CAD Data.....	99
Figure 78: Selecting Calibration Point Three of 3-Dimensional CAD Data.....	100
Figure 79: Test Part Mode for CAD Data.....	101
Figure 80: Generate Menu.....	102
Figure 81: Test Arm Mode.....	103
Figure 82: Examples of Instances of Plane Stock-Object.....	105
Figure 83: Examples of Instances of Cylinder-Section Stock-Object.....	105
Figure 84: Examples of Instances of Full-Cylinder Stock-Object.....	105
Figure 85: Examples of Instances of Spherical-Arc Stock-Object.....	105

---

---

Figure 86: Points 1 to 3 of plane stock-object calibration (left to right) .....	106
Figure 87: Points 1 to 5 of cylinder-section calibration (left to right, top to bottom) .....	107
Figure 88: Points 1 to 5 of full cylinder calibration (left to right, top to bottom).....	107
Figure 89: Points 1 to 4 of spherical-arc calibration (left to right,).....	108
Figure 90: Calibrating Point 1 of Cylinder-Section Stock-Shape.....	109
Figure 91: Information on Plane Stock-Object Class.....	109
Figure 92: Information on Cylinder-Section Stock-Object Class .....	110
Figure 93: Information on Full Cylinder Stock-Object Class.....	110
Figure 94: Information on Spherical-Arc Stock-Object Class.....	111
Figure 95: Test Part Mode with Plane Stock-Shape .....	112
Figure 96: Test Part Mode with Cylinder-Section Stock-Shape .....	113
Figure 97: Test Part Mode with Full-Cylinder Stock-Shape.....	113
Figure 98: Test Part Mode with Spherical-Arc Stock-Shape .....	114
Figure 99: Translation of 3D object .....	116
Figure 100: Start of rotation of 3D object .....	118
Figure 101: Rotation of 3D object with mouse outside of rotation sphere .....	118
Figure 102: Rotation of 3D object with mouse inside of rotation sphere .....	118
Figure 103: Zoom around point on 3D object .....	119
Figure 104: Inspect region of 3D Object.....	120
Figure 105: Reset view of 3D object.....	121
Figure 106: During Scanning with RapidScan 3D - ACB View.....	122
Figure 107: During Scanning with RapidScan 3D - ACBC View .....	123
Figure 108: Evaluating A and B-scans in 3-Dimensions using the Mouse.....	124
Figure 109: Linear Defect Shape Primitive in 3 and 2-Dimensions .....	125
Figure 110: Rectangle Defect Shape Primitive in 3 and 2-Dimensions.....	125
Figure 111: A-scan showing gate set up.....	128
Figure 112: C-scan of area without corrosion.....	129
Figure 113: C-scan of area with corrosion.....	129
Figure 114: C-scan of area without corrosion with pass/fail colour map.....	129
Figure 115: A-scan showing gate set up.....	130
Figure 116: C-scan of six delaminations .....	131
Figure 117: A-scan from a near surface defect (0.7mm depth) .....	131
Figure 118: C-scan with all defects marked for evaluation.....	132
Figure 119: Defect information for Circle 1.....	132
Figure 120: Defect information for Polygon 1.....	132
Figure 121: A-scan showing gate set up.....	133
Figure 122: C-scan of amplitude of the back wall signal .....	134
Figure 123: C-scan of time of flight of the back wall signal.....	134
Figure 124: A-scan showing variable width gate set up.....	135
Figure 125: A-scan showing same gate set up on a thicker part of the structure .....	135
Figure 126: C-scan showing amplitude of internal flaws .....	136
Figure 127: C-C-A view showing two simultaneous C-scans .....	136
Figure 128: A-B-C view showing evaluation of internal flaws .....	137
Figure 129: C-scan of internal flaws with pass / fail colour map.....	137

---

---

<i>Figure 130: C-scan and setting up a new colour map .....</i>	<i>138</i>
<i>Figure 131: C-scan showing applied logarithmic colour map .....</i>	<i>138</i>
<i>Figure 132: A-scan of a good bond.....</i>	<i>140</i>
<i>Figure 133: A-scan of a partial bond.....</i>	<i>140</i>
<i>Figure 134: A-scan of a disbond.....</i>	<i>141</i>
<i>Figure 135: C-scan of the amplitude of the bond line signal .....</i>	<i>141</i>
<i>Figure 136: T-scan of the amplitude of the bond line signal .....</i>	<i>142</i>
<i>Figure 137: Same T-scan with the origin moved to the top left rivet .....</i>	<i>142</i>
<i>Figure 138: T-scan of amplitude of bond line signal .....</i>	<i>143</i>
<i>Figure 139: T-scan of amplitude of back wall signal.....</i>	<i>144</i>
<i>Figure 140: T-scan of amplitude of bond line signal relative to back wall signal.....</i>	<i>144</i>
<i>Figure 141: Display Properties choice .....</i>	<i>147</i>
<i>Figure 142: Display Properties Settings tab.....</i>	<i>148</i>
<i>Figure 143: Primary display at 1680x1050 pixels.....</i>	<i>149</i>
<i>Figure 144: Secondary display at 1024x768 pixels .....</i>	<i>149</i>

## **1. General Information**

This manual corresponds to Sonatest Ltd. RapidScan version 5.0.0.

### **1.1. Warranty**

Sonatest Ltd. warrants the RapidScan instrument to operate within specification under normal use for a period of one year from the date of shipment. In exercising this warranty, Sonatest Ltd. will repair or, at its option, replace any product returned within the warranty period, provided that the product is shown to be defective due to workmanship or materials and that the defect has not been caused by misuse, neglect, accidental or abnormal conditions or operation.

This warranty is in lieu of all other warranties, expressed or implied, including but not limited to any implied warranty of merchantability, fitness, or adequacy for any particular purpose or use. Sonatest Ltd. shall not be liable for any special, incidental, or consequential damages, whether in contract or otherwise.

**With the exception of the mains inlet fuse and the replenishment of water within the wheel transducer, this product contains no serviceable parts. Attempts to service the instrument by persons other than Sonatest Ltd. personnel or agents will invalidate this warranty.**

## **1.2. Equipment Directive Conformance**

This product conforms to the following European Directives:

Directive 2004/108/EC on Electromagnetic Compatibility (EMC)

EU Harmonised Standard BS EN 61326-1:2006 Group 1 Class A  
Equipment

NB: This appliance is not suitable for use within a residential  
environment. Please contact Sonatest for clarification.

Directive 2006/95/EC on Low Voltage (LVD), CE Marked 2008


EU Harmonised Standard BS EN 61010-1: 2001

Directive 2002/95/EC on the Restriction of the Use of certain Hazardous  
Substances in Electrical and Electronic Equipment (RoHS)


Directive 2002/96/EC on Waste Electrical and Electronic Equipment (WEEE)




In addition to FCC Part 18 Verification.


### **1.3. Risks and Hazards**

 Potential risks and hazards are marked by this exclamation symbol in the RapidScan manual. The operator should familiarise themselves with these details.

### **1.4. Operating Conditions**

 If the equipment is used in a manner not specified by the manufacturer, the protection provided by the equipment may be impaired.

	Operating temperature:	5°C to 40°C
	Maximum relative humidity:	95%
	IP rating:	IP40 (unprotected against ingress of dust particles or moisture)
	Supply voltage fluctuation:	±10% of nominal voltage supply


 Do not operate with fans obstructed.  
Do not operate with fan filter covers removed.

### **1.5. Equipment Terminal Ratings**



#### **1.5.1. Mains supply**

	Input voltage:	115-230V AC
	Input current:	0.5-1.0A
	Input frequency:	50-60Hz

#### **1.5.2. Encoder Inputs**


 Maximum voltage input: 5V DC


#### **1.5.3. External Devices Connection**

	Maximum voltage input:	5V DC
	Maximum output voltage:	5V DC


### **1.6. Equipment Installation**

#### **1.6.1. Assembly Location and Mounting Requirements**

 Always position the main RapidScan unit on a stable, flat surface.

 Do not operate the wheel-probe or other water-coupled ultrasonic device within 1 metre horizontally from the main RapidScan unit.

#### **1.6.2. Protective Earth and Connection to Supply**

 Earth and power connection is made via main IEC-type cable.



### ***1.7. Operator Requirements***


Operators must receive adequate training before using RapidScan. Operators must be trained in general ultrasonic testing procedures and in the set up and performance required by each specific test or inspection. Operators must have experience of and be qualified to use standard ultrasonic flaw detectors and C-scan scanning equipment. Operators must understand:

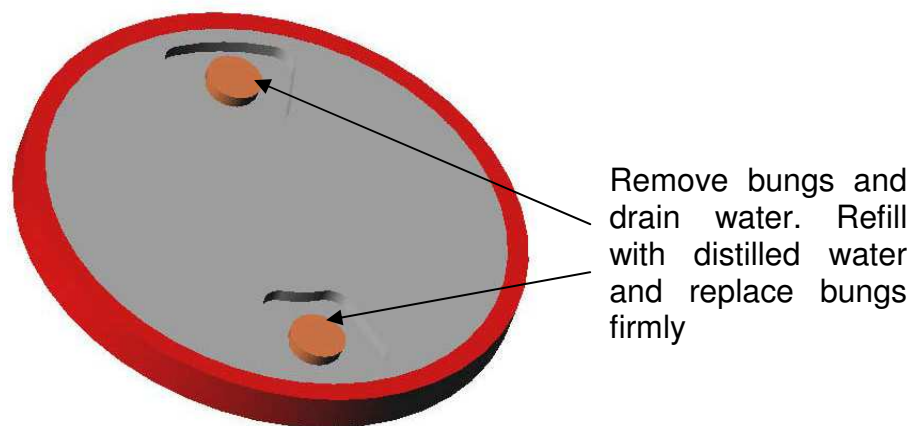
- Sound wave propagation theory
- Effects of the velocity of sound in the test material
- Behaviour of the sound wave at the interface of two different materials
- Sound wave spread and mode conversion
- Operation and triggering of gates for C-scan capture

More specific information about operator training, qualification, certification and test specifications can be obtained from technical societies, industry groups and government agencies.

### **1.8. Maintenance Requirements**

The wheel transducer should be completely drained and refilled with distilled water on a fortnightly basis. The wheel transducer should not be left full of water for a sustained period. The wheel transducer should be drained and filled by removing the two bungs in the end cap of the wheel. After filling, these should be firmly replaced.

 Please ensure that draining and re-filling of the wheel-probe is performed at least 1 metre away from the main RapidScan unit in a location suitable for wet processes to avoid water ingress into the system.



**Figure 1: Wheel Probe Bung Locations**

The laptop should be kept in a dust free environment when not in use. No user maintenance is required.

Periodic cleaning of the main RapidScan unit, using a slightly damp lint free cloth, is recommended.

In the case of visual defects or software abnormalities please refer to the service procedure of section 1.9. If it is suspected that the inlet fuse has failed then it should be replaced with a T 5A H 250V type.

### **1.9. Service Procedure**

Should the equipment become inoperative please contact:

Sonatest Ltd.  
Unit 1-3 Prospect House  
Colliery Close  
Ireland Business Park  
Staveley  
Chesterfield S43 3QE  
UK

Tel: +44 (0) 1246 474269

Fax: +44 (0) 1246 474089

email: [ndts@sonatest.com](mailto:ndts@sonatest.com)

web: [www.sonatest.com](http://www.sonatest.com)

## **2. System Description**

### **2.1. Overview**

RapidScan is a multiple channel ultrasonic inspection instrument. It utilises an ultrasonic array transducer in order to inspect a wide area of a part without any physical motion. The instrument records data very quickly and retains it allowing post-capture examination of the A-scans. The instrument has powerful real-time gating so that the data can be analysed as C-scans to simplify evaluation and interpretation. Since full waveform data is captured, the gating parameters and the C-scans are easily changed and updated without the need to repeat scanning.

The system uses a wheel probe; a linear array of ultrasonic transducers positioned across the width of a wheel. As the wheel probe is rolled along a surface, a positional encoder allows its movement to be tracked so that B-scan traces are captured at the required spacing. Powerful data capture and processing hardware in the RapidScan main unit acquire the data and apply the user-defined gating rules to produce a C-scan image in real time.



**Figure 2: The RapidScan Instrument**

### 2.2. Specifications

#### 2.2.1. Ultrasonic Array

Centre frequency:	1 - 15 MHz
Bandwidth:	> 60% (-6 dB)
Sensitivity:	Dependant on the pulse duration that can be accepted (the array manufacturer Imasonic S.A. can integrate active matching circuitry to maximise sensitivity if required)
Element pitch:	0.4 mm - 2 mm (typical)
Max. array width:	10 mm - 200mm
No. of elements:	Up to 128 dependant on array width
Max. cable length:	10 m @ 10 MHz

#### 2.2.2. Ultrasonic Electronics

No. of channels:	128
System bandwidth:	20 MHz
Receiver gain:	0 dB – 80 dB
TCG:	
No. of definable points:	20
Amplitude resolution:	0.3 dB
Time resolution:	10 ns
Total correction:	80 dB
Slope range:	0 - 40 dB/ $\mu$ s
TCG trigger:	Static and interface trigger
Pulser type:	Square wave
Pulser amplitude:	-70V $\pm$ 10% (minimum of 8 elements fired simultaneously, therefore a very high energy excitation)

#### 2.2.3. Processing Electronics

Processor for evaluation:	Intel Core 2 Duo (2.0GHz, 800MHz, 2MB)
Processor for data capture:	800MHz FPGA
Hard drive:	120GB (typical)
Memory:	2GB (expandable to 4GB)
Sample rate:	40MHz - 100 MHz
Sample bit depth:	12 bit

### **2.2.4. Scan Velocity**

Dependant on several factors including:

- 1) Thickness of substrate
- 2) Acoustic velocity
- 3) PRF (limited by above)
- 4) No. of points in A-scan (limited by above)
- 5) Size of array
- 6) Whether or not data is processed & displayed in real-time
- 7) Time for probe relocation at end of line scan

Typical scan rates in excess of 200mm/s are achievable

### **2.2.5. External Dimensions of Instrument**

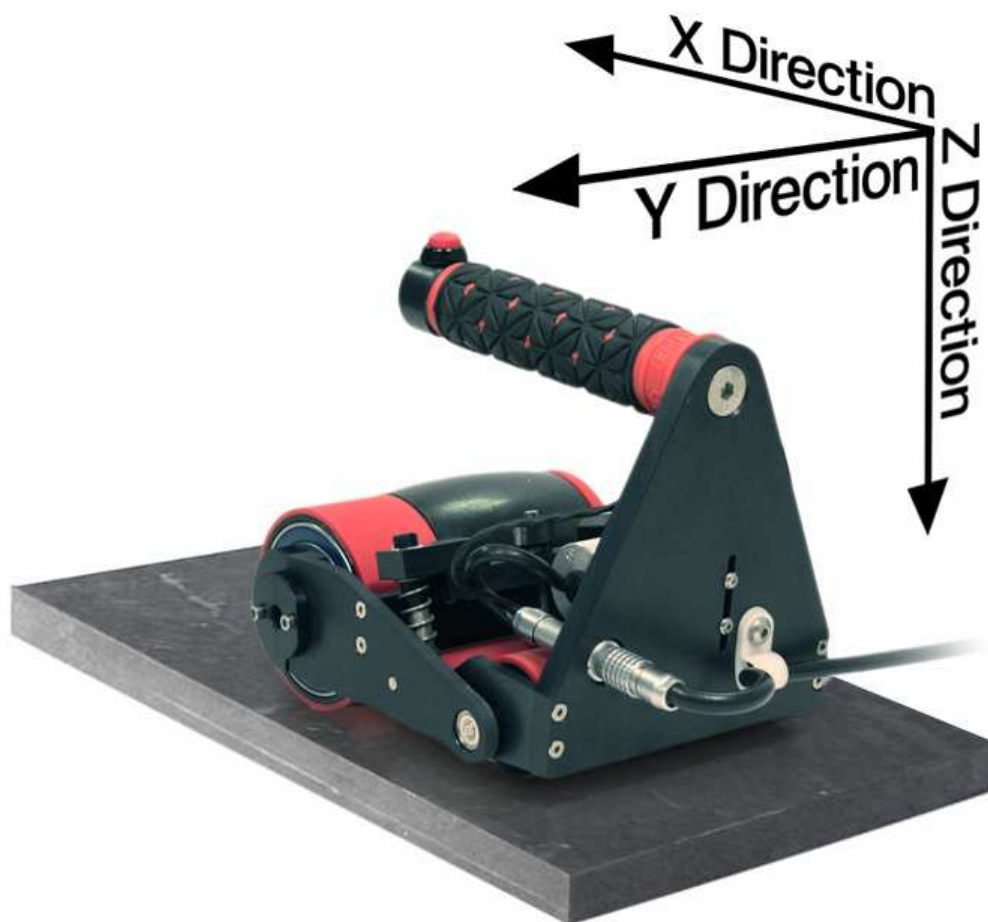
These dimensions include the supplied laptop.

Width:	~525 mm
Height:	~220 mm
Depth:	~420 mm
Weight:	15 kg

## 3. System Concepts

### 3.1. Conventions

The definitions of the three axes of RapidScan are as follows. X direction is the scanning direction, i.e. the direction that the wheel probe rolls in when pushed forwards. Y direction is the scan index direction, i.e. along the length of the array transducer. Z direction is depth into the tested structure. The A-scan is the representation of the echoes received from the material beneath the transducer.

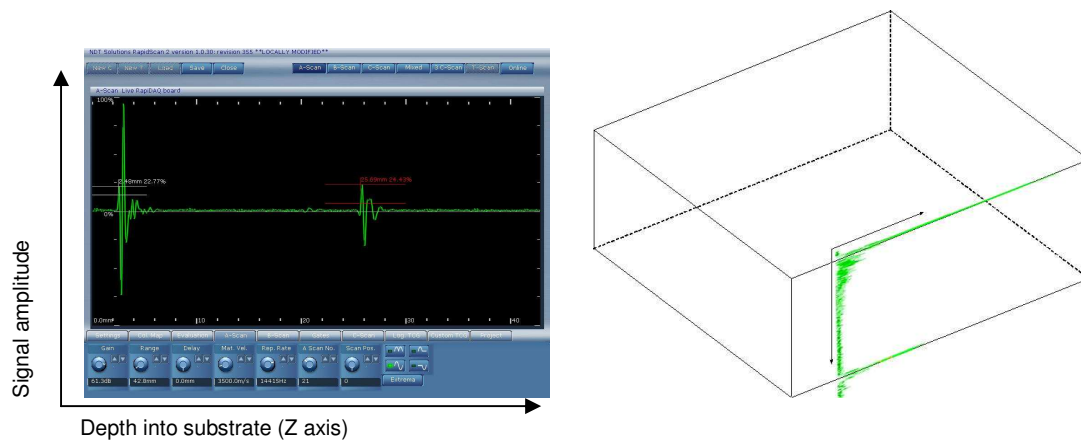


**Figure 3: Axial Convention for RapidScan**

Combining A-scans from several adjacent points on the Y-axis to a single display provides a B-scan, effectively showing a 'slice' through the structure. Additionally, gates are utilised to extract key information from the A-scan data (e.g. the amplitude of a specific echo). Displaying this information on a X-Y plot, referred to as a C-scan, can provide quick yet detailed information about the structure for fast data analysis.

### 3.2. Scan

A display in which the received pulse amplitude is represented along the Y-axis and the travel time of the ultrasonic pulse (equivalent to depth in most cases) is represented along the X-axis.



**Figure 4: A-Scan Convention**

. There are different kinds of single presentations possible:

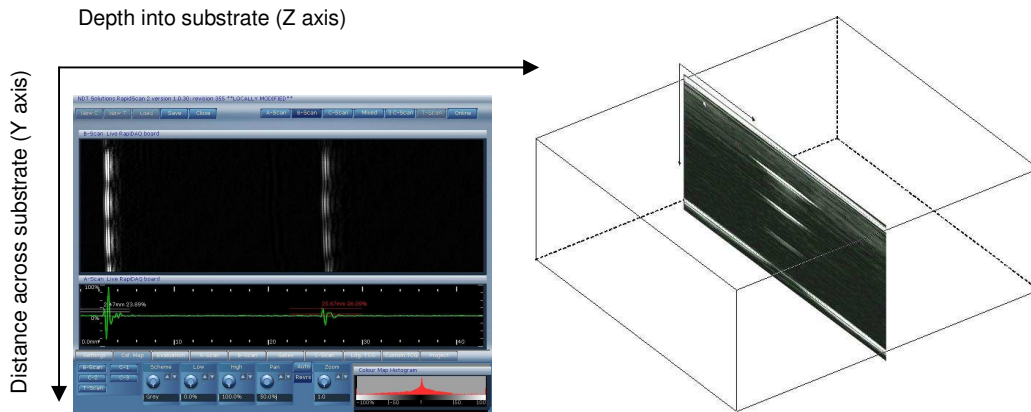
1. Both half waves unrectified (RF),
2. Positive half wave,
3. Negative half wave,
4. Rectified,

An RF display is necessary for investigation of the signal phase shift (e.g., boundaries). Other presentations are useful for simplifying the result and its interpretation. A-scan displays are sometimes complex because it is the principles that are displayed, so multiplied signals (skips of back wall, waterpath) and wave conversion need careful interpretation.

### 3.3. B-Scan

A two dimensional graphical presentation, in rectangular coordinates, in which the travel time of an ultrasonic pulse is represented as a displacement along one axis, and transducer movement is represented as a displacement along the other axis. In the presentation, the signal amplitudes of reflected pulses are displayed using a colour palette (e.g. greyscale).





**Figure 5: B-Scan Convention**

In phased array equipment, a B-scan may be produced in real time. A small number of elements are pulsed to produce a single beam. The adjacent elements are then pulsed to produce the next beam. This sequence is repeated over the full length of the array transducer providing a line of A-scans, displayed as a B-scan. This type of B-scan is sometimes referred to as an E-scan (electronic scan) or an L-scan (linear scan).

#### **3.4. Gates**

Electronic means of selecting a segment of the time base range for monitoring or further processing. A gate is set to search within a specific time segment to identify a signal feature. Each gate records the depth and amplitude of the selected signal feature. Within a gate, it is possible to measure the amplitude of one feature and the depth of a different feature. Using the gate output data it is possible to generate a wide range of C-scans.

#### **3.5. C-Scan**

A two-dimensional graphical presentation displaying the gate information obtained relating to signal features in a top, plan view of the test structure. In the presentation, the two-dimensional data is displayed using a colour palette (e.g. greyscale). A variety of information relating the features selected with the gates may be displayed for different evaluation methods:

1. Signal amplitude of a selected feature,
2. Depth of a selected feature (calibrated from the time base using material velocity),
3. Depth of a selected feature relative to the depth of another selected feature (thickness of material, depth of bottom surface relative to top surface),
4. Signal amplitude of a selected feature relative to the signal amplitude of another selected feature (comparison of echo amplitude, measurement of reflection coefficient).

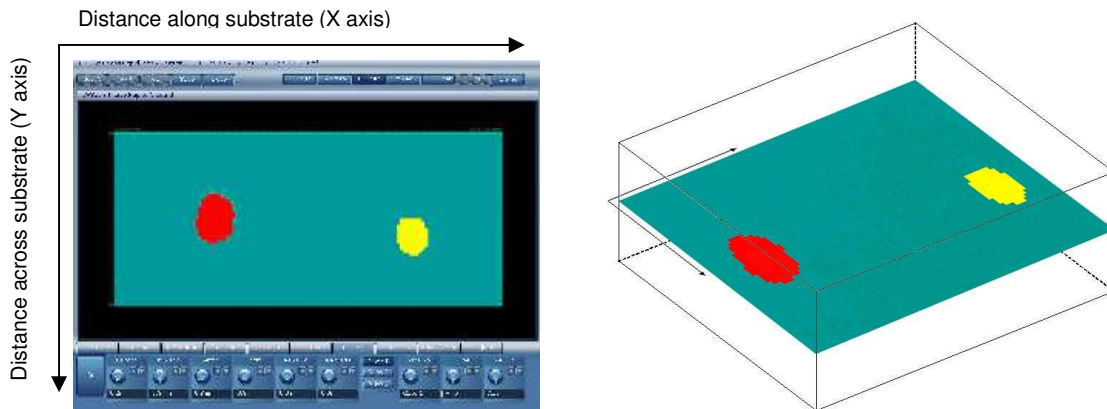


Figure 6: C-Scan Convention

### 3.6. Ultrasonic Array Transducers

An ultrasonic array is comprised of a single piece of piezo-composite material laser cut to form a series of discrete transducers, referred to as elements. In the standard wheel probe, a 6.4mm × 51.2mm piece of piezo-composite is cut into 64 elements of 0.8mm width. The thickness of the piezo-composite determines its resonant frequency and hence the frequency of the array transducer at which the largest amplitude signal can be generated. The electrical signal used to excite the piezo-composite is a negative square wave pulse, the width of which is selected by the user when choosing the array centre frequency in the settings. A pulse width corresponding to the half-wave cycle period usually provides the optimum excitation for any given transducer.

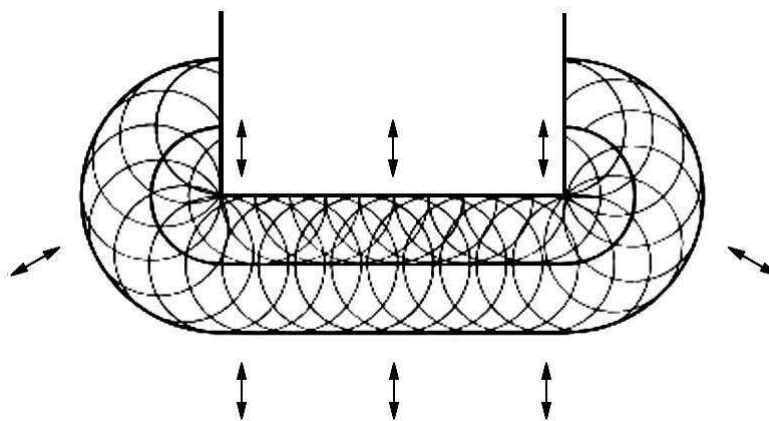
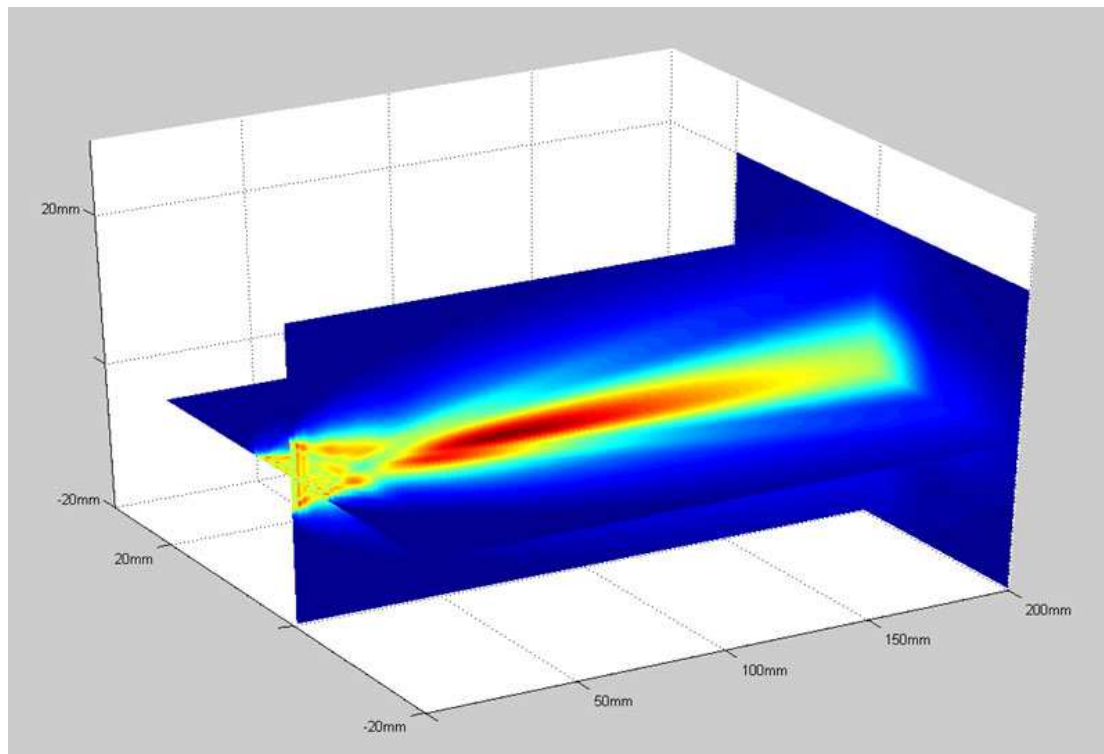


Figure 7: Huygen's Principle

When a single small element is pulsed, it emits a spherical wave. When several elements are pulsed simultaneously, the spherical waves interfere both constructively and destructively, combining to form a plane wave. The effect of pulsing different numbers of elements of different sizes has been extensively modelled in a three-dimensional simulation. For the chosen dimensions for the array transducers, a minimum of 8 elements should be

pulsed together. RapidScan has the capability to pulse groups of 8, 16, 24, or 32 elements making it suitable for use with a range of possible array transducer dimensions.



**Figure 8: Model of Beam Formed by 8 Elements**

Within the RapidScan, the beam is the group of elements that are pulsed together at any one point. The beam number corresponds to the lowest numbered element within the beam, e.g. pulsing elements 5-12 together would form beam number 5.

For a 64-element array and an aperture (number of elements per beam) of 8, beam 57 comprises elements 57-64. This is the highest available beam position for a 64-element transducer since beam 58 would require use of element 65. For the standard arrays of 51.2mm length, an active area of 44.8mm may be used.

### ***3.7. Coupling the Wheel Probe***

The design of the wheel probe enables only a minimal amount of couplant to be used in order to achieve excellent coupling results. Spray a fine mist of water onto the test piece immediately prior to scanning, ensuring that the full scan area is covered. For rough or uneven surfaces, extra water spraying may be required to ensure good coupling around raised features. Alternatively, adding a small amount of liquid to the water will aid the wetting of the surface. Re-spray the surface before each scan is performed.

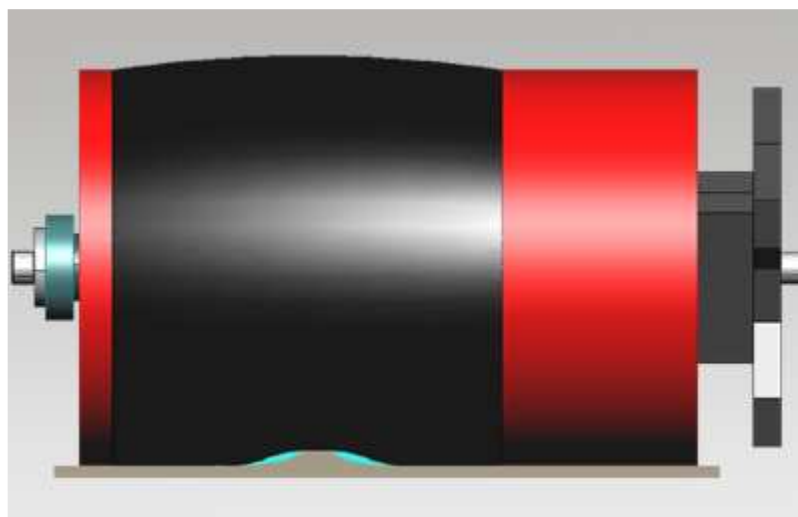


Figure 9: Water Coupling around a Raised Feature

### **3.8. Time Corrected Gain (TCG)**

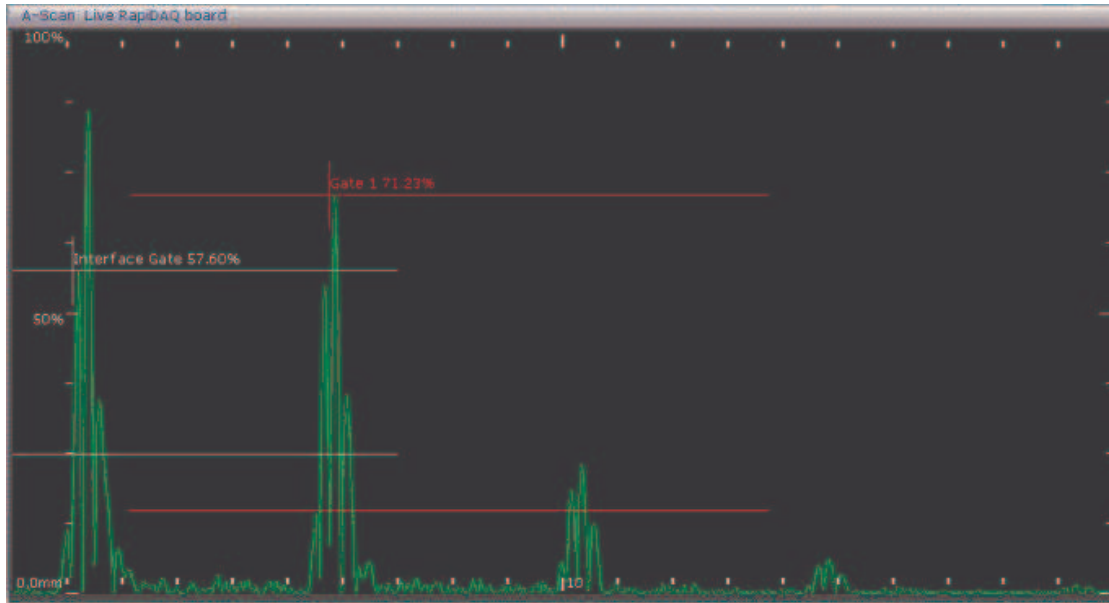
Time Corrected Gain, TCG, sets variable receiver gain over the time base of the A-scan. The primary function of TCG is to compensate for signal attenuation as well as variations in the energy of the sound field through the depth of a material. For a correctly implemented TCG curve, the amplitudes of echoes from reflectors of equal size at different depths in the same material are equal. The gain setting shows the amplification level at time zero with the curve being relative to that level.

There are two types of TCG curve available, logarithmic and custom. The logarithmic curve varies the gain at a fixed gradient (dB/mm). Alternatively, the user can setup a custom curve using a calibration block with points set at specific depths. It is possible to create an editable custom curve from a logarithmic curve. The interface gate may be utilised to trigger both curve types, locking the gain level to the interface.

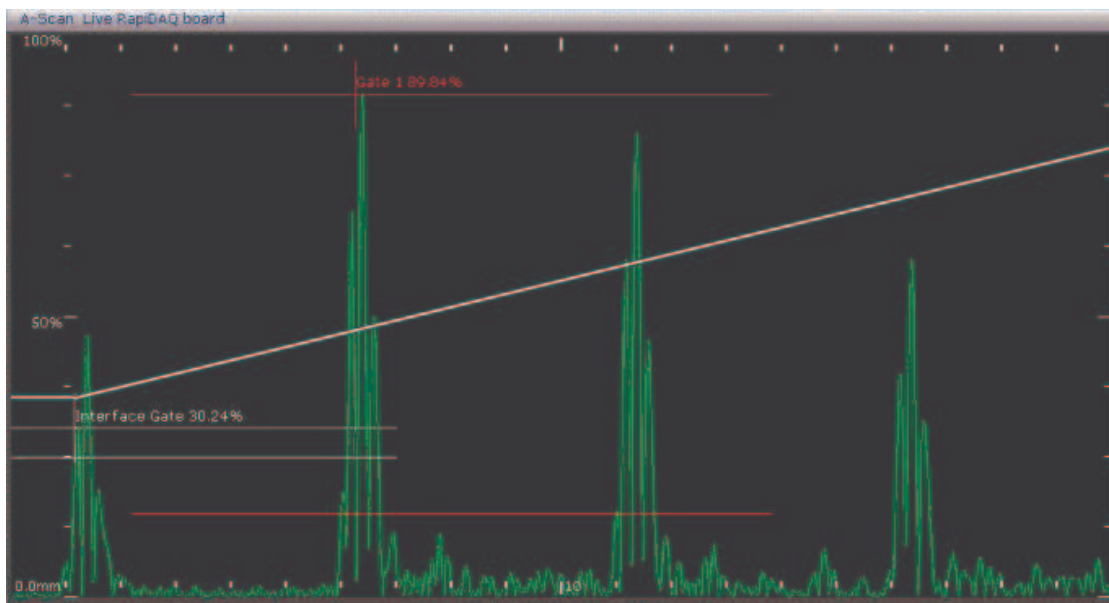
The following screen shots show a comparison between A-scan responses of the same test structure without TCG, with simple Log TCG curve, and with a custom TCG.

### 3 System Concepts

---



**Figure 10: A-Scan of Structure with No TCG Applied**



**Figure 11: A-Scan of Structure with Log TCG Applied**

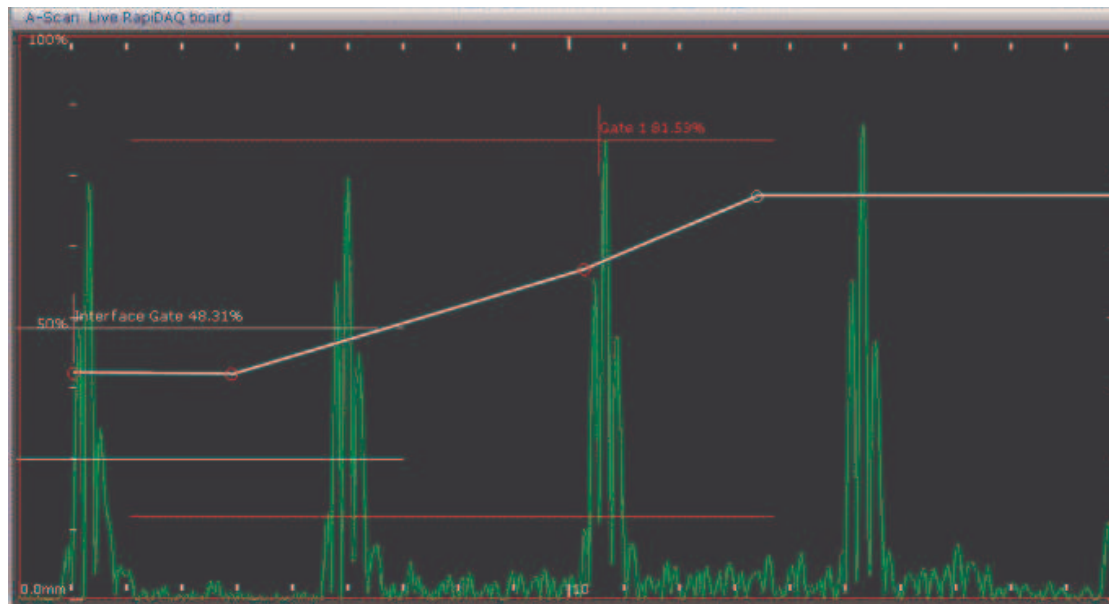


Figure 12: A-Scan of Structure with Custom TCG Applied

### 3.9. T-Scan

The T-scan (tiled scan) is essentially a composite C-scan. The user defines the size of an area that becomes the T-scan canvas. C-scans are added onto the canvas in order to combine multiple 'stripes', recorded using the wheel probe, into a single compound image. Similar to the C-scan view, the user selects which gate and data type to view, may adjust the colour palette and, most importantly, use the evaluation tools to mark up and measure defects. The T-scan operates with either just C-scan images (xxx.cscan.tif) or full waveform data (xxx.abcsan.tif), both of which are saved when recording a single C-scan. When evaluating full waveform data, it is possible to redefine the gates and recalculate the entire T-scan providing the freedom to re-analyse recorded data without the need of repeating the scans. It is possible to move, rotate and blend C-scan stripes as well as import multiple stripes with constant offset for easy assembly of large area scans. T-scans may be saved as RapidScan files or bitmap images and the user can print scaled or actual size (multiple sheet) images directly from the software for over-lay onto a part.

## ***4. Using RapidScan for the First Time***

### ***4.1. Equipment Checklist***

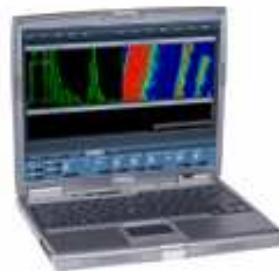
#### **Wheel Probe:**

Hand-held scanning device. An ultrasonic array transducer is housed within the water filled rubber wheel. A position encoder is attached to the axis of the stabilising wheels to record the distance that the wheel has travelled.



#### **Laptop:**

A standard laptop is supplied with the RapidScan. The manufacturer and specification will depend on individual customer requirements.



#### **RapidScan Unit:**

A portable processing unit containing all the hardware for the array transducer and for the capture and storage of scan data.





### 4.1.1. Optional Add-Ons

#### **Head-Up Display:**

Head set display unit, worn like glasses. Contains a display to assist remote scanning where laptop visual access is restricted.



#### **Cordless Mouse:**

A cordless mouse with USB adaptor can be supplied as an option






## 4.2. Connecting RapidScan Components

### 4.2.1. Connecting Power to the Instrument

All the RapidScan equipment should be connected together before turning the power on. The connections to be made are as shown in the diagram.



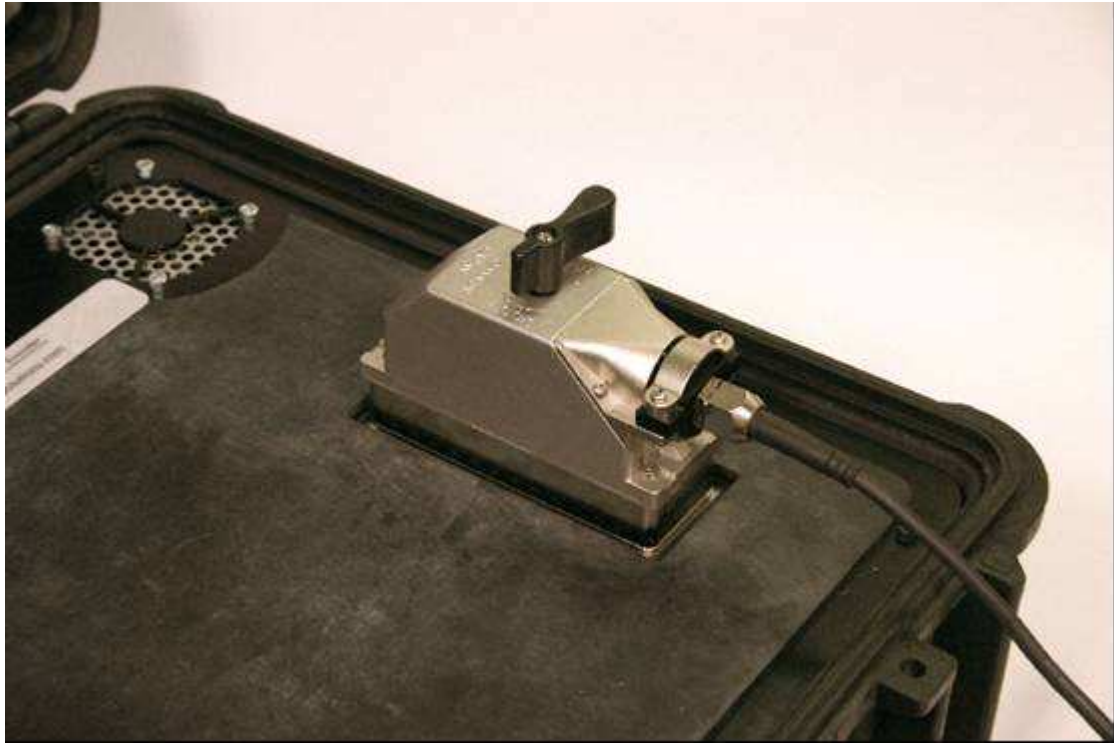
**Figure 13: RapidScan Power Cable Connector**

 Insert the mains cable into the RapidScan as shown above, and switch the unit on using the power switch. If the button does not illuminate when switched, check the condition of the fuse. The fuse holder is located below the socket.

The equipment is able to run on 110V AC power or 220V AC power.

Ensure that equipment is located such that there is easy access to mains socket for removal in the event of an incident.

### 4.2.2. Connecting the Wheel Probe




**Figure 14: RapidScan Wheel Probe Connector**


**⚠** Connect the wheel probe to the RapidScan by plugging in the large multi-way connector as shown above. With the connector unplugged, turn the black handle on the connector to the open position and offer the connector up to the RapidScan unit. No force should be required in order to do this. If the connector does not fit with zero force applied, check the condition of the connector terminal pins. With the connector in place, turn the handle to the lock position.



**Figure 15: RapidScan Position Encoder Connector**

-  Insert the wheel-probe encoder connector into the first encoder socket on the RapidScan, see Figure 15

### 4.2.3. Connecting the Laptop

-  Connect power to the laptop, and ensure that the PCMCIA cable is inserted into the PCMCIA adaptor in the laptop instrument. The illuminated power switch must be on and the PCMCIA adaptor connected to the laptop before the laptop is switched on.

### **4.3. Installing Software on the RapidScan Laptop**

The RapidScan instrument is delivered with all the hardware drivers and application software necessary to start using it. Please contact Sonatest Ltd. if, for any reason, you suspect there is anything wrong with your installation.

A number of drivers are required in order to run RapidScan, and the user should not un-install any drivers that are already installed on delivery.

The installation of other applications such as games is not recommended, since the RapidScan software uses DirectX v9. Any changes to the DirectX configuration or the graphics drivers may prevent the correct operation of RapidScan.

#### **4.3.1. The Setup CD**

The Setup CD contains the following:

- **apps\setup\_x.y.z.exe** – Installs the RapidScan application on your computer (major version **x**, branch version **y**, minor version **z**).
- **drivers\graphics\DirectX9** folder containing the installation for DirectX9, required by the RapidScan application.
- A **readme.txt** file containing useful information for recovering a corrupted computer. Recovery should only be attempted on the advice of Sonatest Ltd.
- **drivers\card\_adapter** folder containing drivers needed by Windows when setting up a laptop for the first time
- **drivers\data\_capture\rapidaq\_driver** folder containing drivers needed by Windows when setting up a laptop for the first time.

#### **4.3.2. Special Notes Regarding the Operating System**

- Installation and configuration must be carried out while logged on as a user with Windows Administrator rights. Once installation is complete, RapidScan can be run from normal Windows user accounts that do not have Administrator rights.
- The RapidScan Software operates on Windows 2000 or XP platforms.
- The screen resolution must be set to a minimum of 1024x768. Widescreen displays are also supported.
- Colour quality must be set to highest (32 bit).
- The application must run with “Classic” style windows title bars rather than “Windows XP” style title bars.
- Screen savers, and Windows power saving options may cause incorrect operation of the RapidScan software.
- The laptop running the RapidScan software should not be shut down using hibernate.

### 4.3.3. Starting RapidScan

Double click on the RapidScan desktop icon, or launch RapidScan from the Windows Start menu.

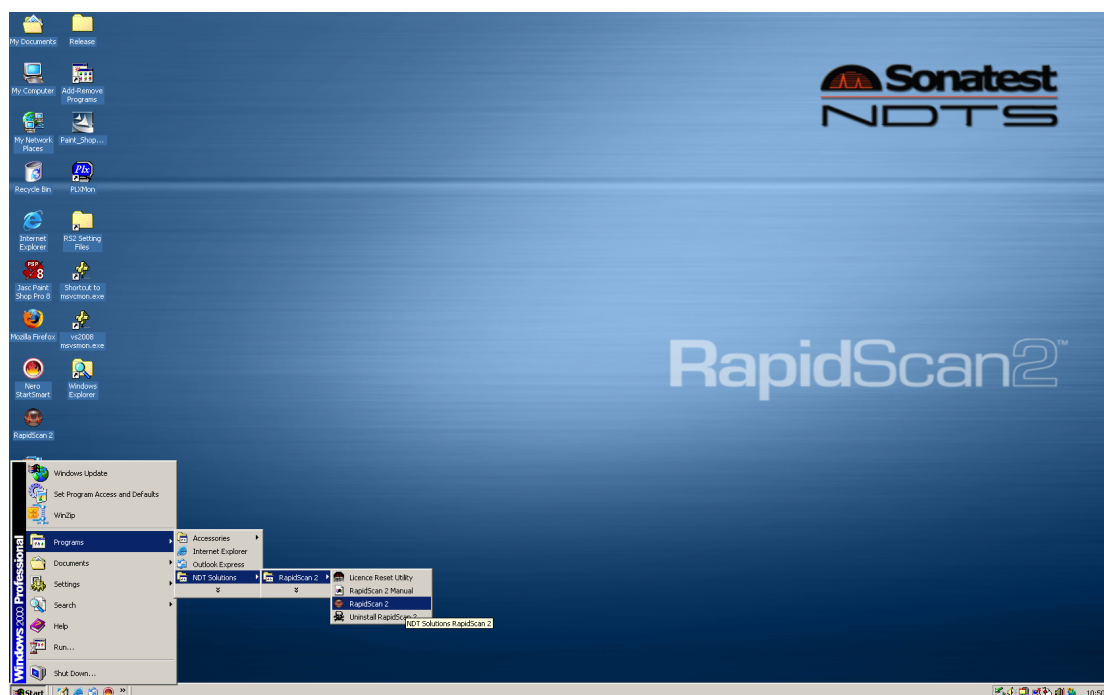


Figure 16: Starting RapidScan from the Start Menu

### 4.4. Logging On (Optional)

The RapidScan may require a user to logon. Figure 17 shows the logon screen. A username is entered in the first edit box control. Pressing return or clicking the OK button immediately starts the application unless a password is required.



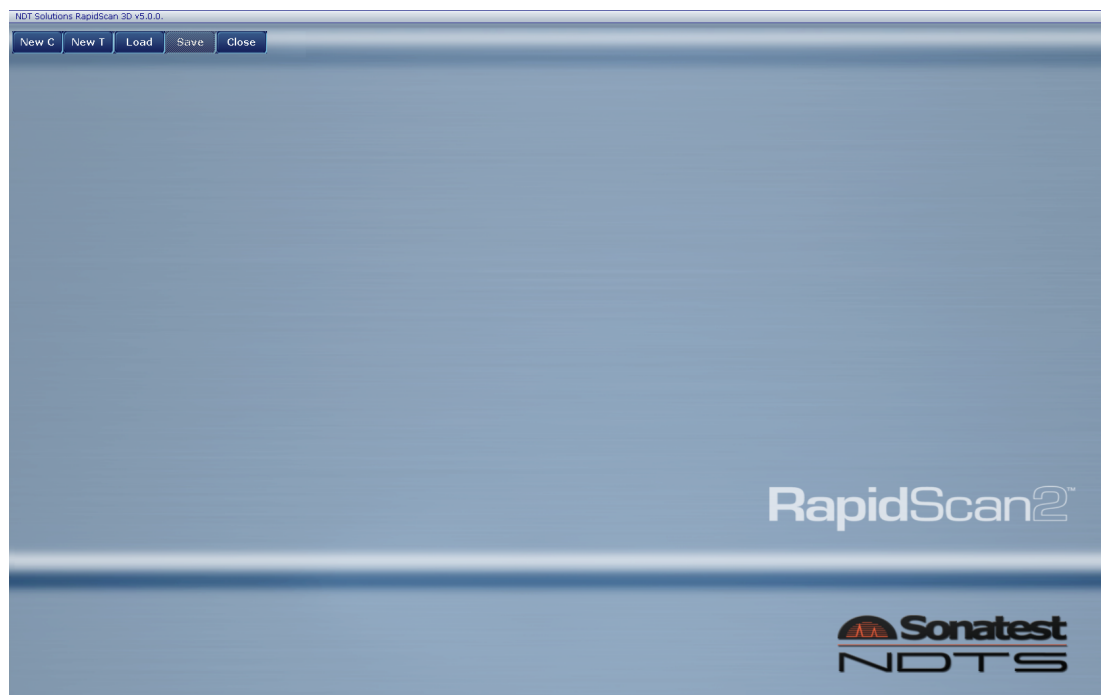
Figure 17: The Logon Screen

The remainder of this document assumes that the user is logged on with **administrator** privilege. Certain controls will not be available if logged on as a user that is not in the **administrator** group.

The users and groups used in the RapidScan software are completely separate from the Microsoft Windows groups and Administrator access rights.

### 4.5. Navigating the RapidScan Menu System

Starting the RapidScan software results in the presentation to the user of the initial screen shown in Figure 18.



**Figure 18: RapidScan Start-up Screen**

The initial screen allows the user to enter the desired program mode. The menu buttons in the top left-hand corner perform the following functions:

<b>New C</b>	Start a new C-scan session
<b>New T</b>	Start a new T-scan session
<b>Load</b>	Load a previously saved C or T-scan session
<b>Save</b>	Saves a C or T-scan session or particular instrument settings
<b>Close</b>	Close current session - Exits RapidScan if session is closed

Activation of the **New C** button only occurs if the computer on which the software is running is connected to RapidScan hardware. If the **New C** button is unexpectedly read-only (greyed out) then shut down the laptop and turn off the illuminated power switch. Check the PCMCIA adapter is fully inserted and that the cable is correctly screwed in to the PCMCIA card. Turn on the illuminated switch. Start the RapidScan laptop. If the **New C** button is still read-only, contact Sonatest Ltd. for further assistance.



## 4 Using RapidScan for the First Time

---

The **save** button is initially disabled on start-up since no data yet exists to be saved. Activation of the button occurs once a session arising from the **New C** or **New T** button click contains scan data.

The **close** button closes the current C or T-scan session if one exists, otherwise the application will close.

### 4.5.1. Navigating a C-Scan Session

During a C-scan session a number of menu buttons are displayed at the top of the screen. Figure 19 shows this strip of buttons.

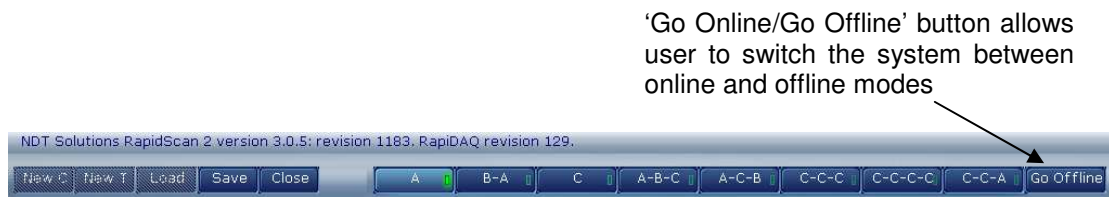


Figure 19: C-Scan Session Top Button Strip

#### 4.5.1.1. Online and Offline Modes

The **Go Offline** button in Figure 18 toggles between **Online** and **Offline** modes.

During a C-scan session, the program is in **online** mode before a C-scan is performed and during the act of C-scanning itself. Once the scan is complete the program reverts to **Offline** mode.

In **online** mode and before a C-scan is started, the A and B-scan windows show a real-time representation of the substrate under the sensor array. The instrument settings, such as gate parameters, may be configured using these views; otherwise the existing machine state from the last scan will be used. During C-scanning, the A, B and C-scan windows show a real-time view of the data which has been collected. The windows update only when C-scan data is collected and are frozen whilst the probe is stationary.

Once a scan has been completed the software changes mode to **Offline** so that the user can evaluate the scan, mark defects, save data and perform other necessary tasks. Certain settings are then fixed as read-only since they are intrinsic to the data that has been captured, e.g. the A-range range.

Assuming a scan has been acquired and the program is now in the **Offline** state, the **Online** state can be selected to provide real-time views of the selected A and B-scans as a precursor to performing another C-scan.



### 4.5.1.2. Creating an Online C-Scan Session

Selecting **New C** in the start-up screen shown in Figure 18 starts an online C-scan session.

### 4.5.1.3. Loading an Offline C-Scan Session

Selecting **Load** in the start-up screen shown in Figure 18 allows an offline C-scan session, saved in RapidScan's multi-page TIFF format, to be recalled.

### 4.5.1.4. Available Views in a C-Scan Session

The buttons on the right-hand side of Figure 19 are used to set how the instrument is used to view the various types of data which are available. RapidScan is supplied with a number of preconfigured views which can be chosen to best represent a given aspect of the A, B and C-scan data.

- **A** A large A-scan view (Figure 20)
- **B-A** A large B-scan and smaller A-scan view (Figure 20)
- **C** A large C-scan view (Figure 21)
- **A-B-C** A medium-sized A-scan, B-scan and C-scan view (Figure 21)
- **A-C-B** A medium-sized A-scan, small C-scan and large B-scan view (Figure 22)
- **C-C-C** Three medium-sized views of C-scans (Figure 22)
- **C-C-C-C** Four smaller-sized views of C-scans (Figure 23)
- **C-C-A** Two medium sized C-scan views and a single large A-scan view (Figure 23)

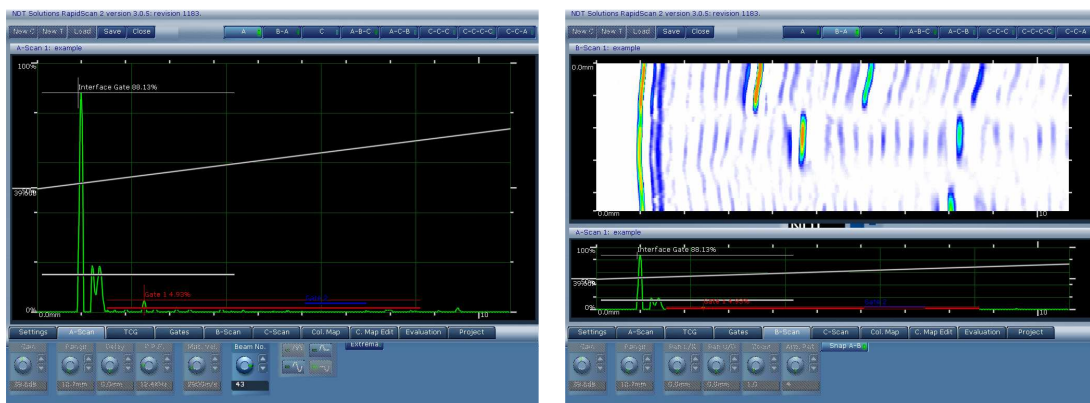


Figure 20: A View and B-A View

## 4 Using RapidScan for the First Time

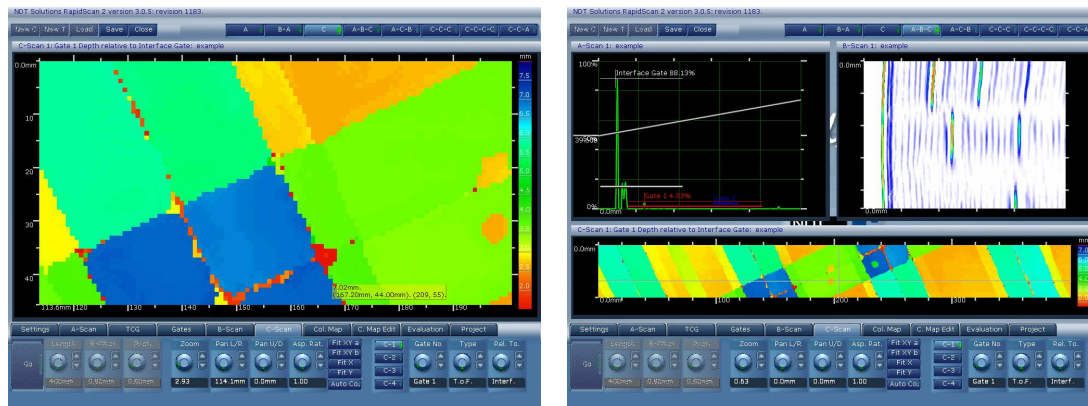


Figure 21: C View and A-B-C View

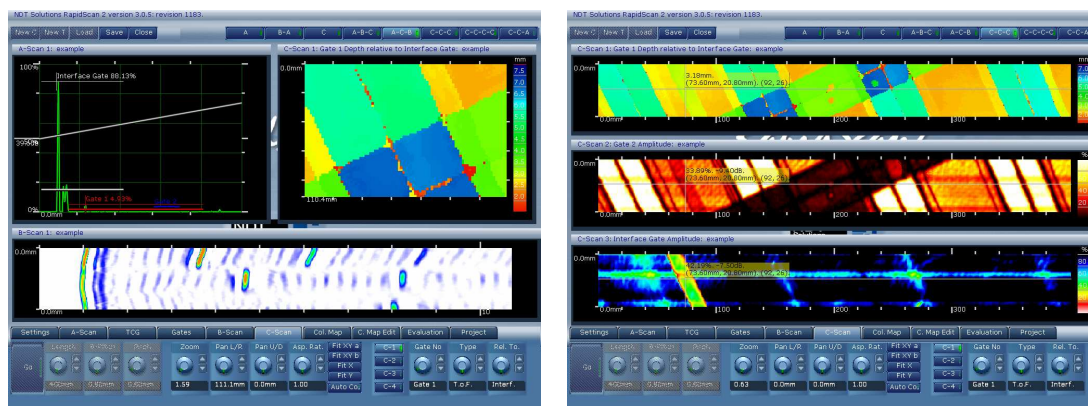


Figure 22: A-C-B View and C-C-C View

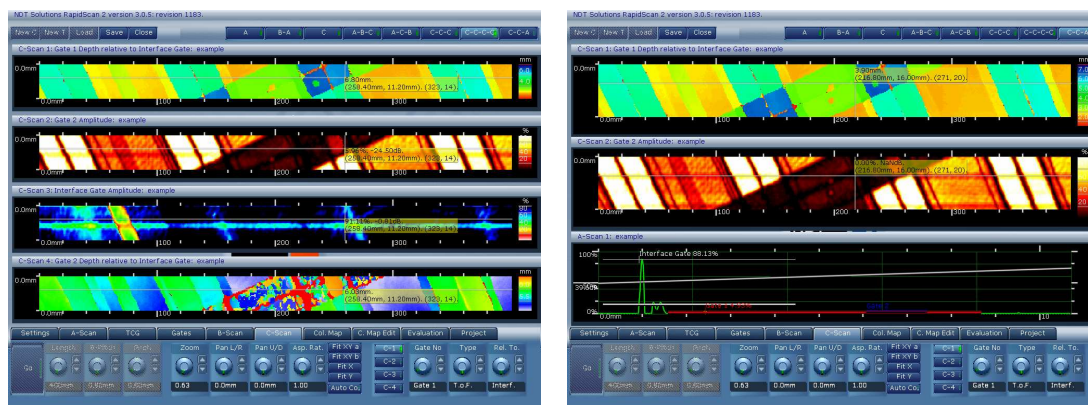


Figure 23: C-C-C-C View and C-C-A View

### 4.5.1.5. Navigating C-Scan Session Sub-Menus

The bottom area of the screen displayed by the program when in a C-scan session shows a number of controls relating to a particular aspect of the machine configuration.



**Figure 24: C-Scan Setting Menu**

Figure 24 shows the C-scan menu. This can be seen by the highlighted state of the **C-scan** tab. The set of controls for a different aspect of the program are displayed by clicking on the appropriate menu tab using the left mouse button. The exact meaning of each of the controls is defined in section 5.6.

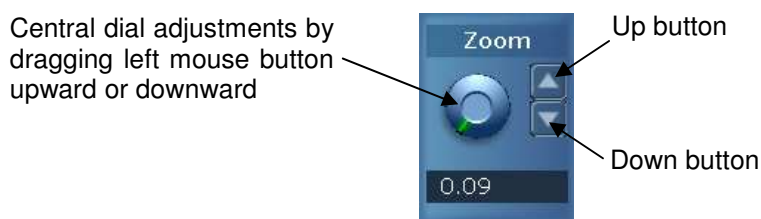
### 4.5.1.6. Using RapidScan Custom Controls

RapidScan features a custom graphical user interface which provides extra functionality over the basic operation of standard Microsoft Windows applications.



**Figure 25: An Example RadioButtons Control**

A number of the settings in RapidScan take their value from a small number of distinct choices, only one of which can be active at a time. These settings are naturally represented by mutually exclusive radio buttons. An example of a set of radio buttons is shown in Figure 25 with the corresponding setting type being the rectification applied to the A-scan signal; the selected rectification type is RF, demonstrated by the green highlighted LED image. The selected button within a radio buttons control is set using a left mouse button click.



**Figure 26: An Example Text-Dial-Arrows Control**

Many of the RapidScan machine settings naturally exist over a range of numbers. For example, the value may be the number of samples in an A-scan or the number of millimetres in the length of a C-scan. Settings such as these are naturally represented and manipulated using the text-dial-arrows control, shown in Figure 26.

A text-dial-arrow control allows the setting to which it corresponds to be altered using either the mouse or the keyboard. The dial in the centre of Figure 26 can be rotated by clicking the left mouse on the dial and dragging upward or downward. Fine adjustments can be made to the value by clicking on the up or down button on the right-hand side of Figure 26. Holding down the left mouse button over one of the arrow buttons causes it to auto-repeat.

The up and down cursor keys can also be used to make fine adjustments to the setting. The left and right cursor keys alter the value by coarser increments. The value can be set to specific values using the keyboard by selecting the text-dial-arrow and typing the desired value. These combination of uses of the text-dial-arrows allow quick adjustments while maintaining full control over the value which the control represents. The dial also provides a visual representation of where the current value lies in terms of the maximum and minimum valid values.

### 4.5.1.7. Closing a C-Scan Session

In order to finish a C-scan session and return to the main menu, use the **C**lose button. Ensure that any work has been saved before closing.

### 4.5.2. Navigating a T-Scan session

During a T-scan session, there are a number buttons shown at the top of the screen at all times.



Figure 27: T-Scan Session Top Button Strip

#### 4.5.2.1. Creating a T-Scan Session

Press the **New T** button in the main menu to start a new blank T-scan session.

#### 4.5.2.2. Loading a T-Scan Session

A previously saved T-scan session can be loaded using the **L**oad button on the start-up screen (Figure 18).

#### 4.5.2.3. Available Views in a T-Scan Session

The current view in a T-scan session may be chosen using the buttons on the right-hand side of Figure 27.

## 4 Using RapidScan for the First Time

- **T** A large T-scan view (Figure 28)
- **A-B-T** A medium-sized A, B and T-scan view (Figure 28)

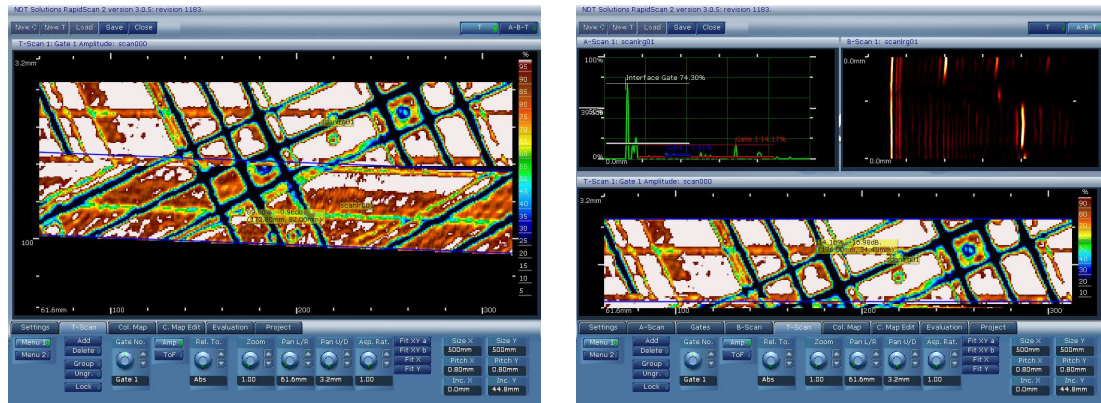


Figure 28: T View (left) and A-B-T View (right)

### 4.5.2.4. Closing a T-Scan Session

In order to finish a T-scan session and return to the main menu, use the **Close** button. Ensure that any work has been saved prior to closing.



## 5. Obtaining a C-Scan using RapidScan

### 5.1. Configuring Fundamental Settings

To configure the RapidScan for a particular wheel probe, or inspection, use the sub-menu 2 in Settings menu, shown in Figure 29.

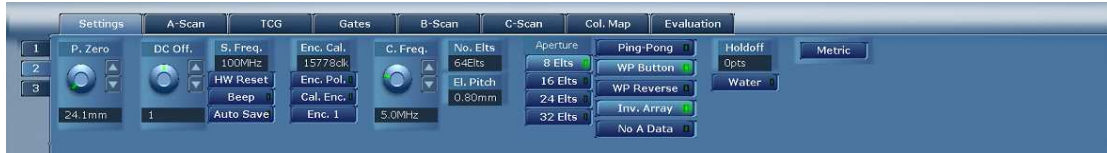


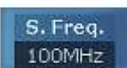



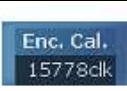














Figure 29: The Settings Menu

Control Title	Ctrl. Image	Description
P. Zero.		Probe zero; compensates for the distance between the elements in the wheel probe and the tyre / sample interface.
DC Off.		DC offset; adjusts the zero mark of the A-scan signal to compensate for variations in the RapidScan hardware.
S. Freq.		Sample frequency; changes the data capture rate of the RapidScan. This setting should only be adjusted under the advice of an Sonatest Ltd. engineer.
HW Reset		Hardware reset; resets the RapidScan ultrasonic hardware.
Beep		This button enables a confirmation beep that sounds when starting and stopping scanning.
Auto Save		Automatically save C-scans to disk after they are created.
Enc. Cal.		Encoder calibration; sets the number of encoder counts per metre.
Enc. Pol		Encoder polarity; the scanning direction of the encoder connected to the instrument.
C. Freq		Centre frequency; sets the natural resonant frequency of the array in MHz.
No. Elts		Number of elements; the physical number of elements within the array.
El. Pitch		Element pitch; the distance between each element of the array.

<b>Aperture</b>		The number of transducer elements to fire simultaneously when recording a single A-scan.
<b>Ping-Pong</b>		Optimises the firing pattern to the array in order to allow increased repetition rates and scanning speeds.
<b>WP Button</b>		Wheel probe button; enables the button on the wheel probe to start or stop a scan.
<b>WP Reverse</b>		Wheel probe reverse; when selected, a scan is taken by moving the wheel probe from right to left instead of the usual left to right direction.
<b>Inv. Array</b>		Invert array; reverses the order of the array elements. Changing the state of this button will cause the C-scan to appear the opposite way up.
<b>No A Data</b>		Disables the storage of A-scan data when C-scanning to greatly reduce the memory required for the scan data.
<b>Holdoff</b>		Sets a hold-off parameter for gate triggering.
<b>Metric/ Imperial</b>		Sets the domain of the units used during display of various data.

### 5.1.1. Array Aperture

The **Aperture** specifies the number of transducer elements which are fired simultaneously when recording an A-scan. Larger aperture sizes mean greater substrate penetration at the cost of reduced resolution across the array; this is analogous to transducer diameter in single element systems.

The aperture indirectly determines the number of beams that make up a B-scan. For example with a 64 element array and an **Aperture** of 8, beam position zero corresponds to firing elements 1..8, beam position one to elements 2..9 up to the maximum beam position of 57, corresponding to elements 57..64. The number of beam positions is therefore the number of physical array elements plus one minus the aperture size. Note that the Pitch Y control in the C-scan menu also affects the effective number of elements in a B-scan.

### 5.1.2. Automatic Velocity Selection

When online, the current value obtained from the C-scan calculation is shown in the C-scan window. The value displayed corresponds to the settings for the C-scan using the currently selected A-scan (the value can be set in **A-scan**

Menu). To determine the velocity of a material, configure a C-scan to measure the thickness. The material velocity can then be adjusted so that the output shown on the C-scan matches the known thickness of the material. A non-iterative approach can be taken where the current (incorrect) material velocity is scaled by the ratio of the actual thickness to the thickness measurement reported by RapidScan.






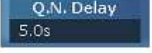

### 5.1.3. Normalising the Array

To configure the RapidScan for array normalisation, use the sub-menu 3 in Settings menu, as illustrated in Figure 30.


Array normalisation is used to set a normalisation level for UAT beams to compensate for variations in sensitivity across UAT elements and/or amplification hardware. Normalisation levels are measured in decibels (dB), where -6dB represents approximately half the gain and +6dB represents double the gain.



Figure 30: The Normalisation Menu

Control Title	Ctrl. Image	Description
<b>Beam No.</b>		Beam number; the beam or aperture to which the normalisation level is applied.
<b>Level</b>		The normalisation level of the selected beam. This value is changed by the automatic array normalisation function and can also be changed manually when necessary.
<b>Norm.Rst.</b>		Set all beam normalisation levels to 1.0.
<b>Normalise</b>		Enable / disable array normalisation. Beam normalisation levels are effectively set to 1.0 when normalisation is disabled.
<b>Q.Norm.</b>		Quick normalization; this feature allows the array to be balanced much more easily and quickly than using the <b>Norm.Set</b> .
<b>Q.N.Delay</b>		The delay in seconds that the system uses before taking a number of B-scans used for normalization.
<b>Q.N.Gate</b>		The gate whose amplitude is used during normalization. This is usually set over the back-wall echo.



<b>Norm. Set</b>		Set beam normalisation levels automatically
------------------	---	---

### 5.1.3.1. Quick Array Normalisation

The interface to the quick normalization contains three controls:

1. Q. Norm button
2. Q.N. Delay edit-box
3. Q.N. Gate text-dial-arrows.

When the Q. Norm button is clicked, the system waits for the number of seconds chosen in the Q.N. Delay edit-box before taking a number of B-scans. Amplitude measurements corresponding to the gate chosen with the Q.N. Gate text-dial-arrows are recorded from these B-scans. These gate measurements are used to work out the correct balancing amplifications for the RapidScan instrument.

The delay has been included to allow the operator to click the Q. Norm button and get the transducer tool in the correct position before the data is sampled. If Beep is selected in the **Settings** menu, then the system will count in the B-scan recording stage and will beep once more when the B-scans are recorded. The user can then remove the tool from its position. If Beep is not selected, then the user can identify when the procedure has completed as the mouse cursor changes from an hour-glass back to the usual arrow.

It is recommended that balancing is performed using the gate positioned on the back-wall echo through a homogeneous material. If this is not available then the interface echo can be used.

Quick normalisation is a simple way to conduct normalization process, and this is a recommended method that can replace the traditional **Norm. Set** method.

### 5.1.3.2. Standard Array Normalisation

A C-scan of a homogeneous object can be used to automatically set beam normalisation levels. Before scanning the object, the following settings must have the correct values:

- Set gate 1 to active in the Gates menu.
- Set the A-scan settings to show the back wall echo.
- Set the “Pitch Y” to the lowest possible value (0.8mm) in sub-menu 1 of **C-scan** menu.
- Set the B-scan Aperture as appropriate.
- Set the C-scan Length to at least 150mm in sub-menu 1 of **C-scan** menu.
- Set the C-scan gate 1 “Type” to Amplitude, and “Rel. To.” to Absolute.

- Set the “Gain” (in **A-Scan** menu) such that the back wall echo does not saturate on any channel during the scan and is clearly distinguishable from the noise floor.
- Set TCG to Off in TCG menu.
- Set gate 1 to cover the back wall echo.

The following process can be used to normalise the array and produce a probe settings file for later use. The process assumes an application settings file exist that configures the setting detailed above.

1. Begin a new C-scan session.
2. Import a settings file that sets the application settings to the appropriate values for the reference block (as described above).
3. Perform a C-scan.
4. Select the Settings menu and the sub-menu 2.
5. Click the Norm. Set button. The normalisation values will be calculated using data from gate 1.
6. Go online.
7. Enable normalisation.
8. Perform another C-scan and check that the array is being correctly normalised.
9. Check the calibration of the encoder clicks per metre if required (see section 5.1.4 below).
10. Save the probe settings to a \*.pro file for later use.

Once a probe settings file exist, the following simple process can be used to produce C-scans with a normalised array and recently calibrated clicks per metre, i.e. using a probe settings file:

1. Begin a new C-scan session by using New C.
2. Import *part.rs2* where *part.rs2* is the settings file that configures the application for the part to be scanned.
3. Import *jan.pro* where *jan.pro* is the probe settings file that configures the application with the normalisation values for the connected probe.
4. Perform C-scans.

The files must be imported in this order, as probe settings are stored within a \*.rs2 file. Therefore, if the probe settings are imported before *part.rs2*, then they will be overwritten with the probe settings at the time that *part.rs2* was created.

### 5.1.4. Automatic Encoder Calibration

A standard wheel probe has approximately 16,000 clicks per metre. A more accurate value for **Enc. Cal.** (in sub-menu 1 of **Settings** menu) can be determined thus:

1. Reset the encoder calibration to 20000 clicks.
2. Set the C-scan length to a fixed value.
3. Start a C scan using the Go button in C-scan sub-menu 1.

## 5 Obtaining a C-Scan using RapidScan

---

- 4 Move the probe forward by exactly the length specified as the C-scan length.
- 5 Press the Stop button. The correct encoder calibration will automatically update.
- 6 Verify the new encoder calibration by repeating the scan and ensuring the scan stops exactly when expected.

The number of clicks per metre is stored in the \*.pro file along with the normalisation settings, as described above in section 5.1.3.2.









## 5.2. Establishing an A-Scan

To configure and view the pulse-echo signal received by a group of elements, use the A-Scan menu, as shown in Figure 31.



Figure 31: The A-Scan menu

The controls are as follows:

Control Title	Ctrl. Image	Description
<b>Gain</b>		The gain of the receiver (dB).
<b>Range</b>		The depth of the A-scan that is sampled and shown on the display (millimetres/inches).
<b>Delay</b>		The start position of the A-scan display from the Probe delay. When operating using a wheel probe, adjust the P. Zero control in the sub-menu 1 of Settings menu. Only use this control to introduce a delay from the wheel probe interface into the material.
<b>P . R . F</b>		The pulser repetition frequency, the rate at which the transducer is fired, in KHz.
<b>Mat . Vel .</b>		Material velocity; sets the velocity of sound in the substrate, in metres per second or inches per microsecond.
<b>Beam No .</b>		The centre of the aperture that is currently being displayed.
<b>Rectification</b>		These buttons select RF, full wave or half wave rectification of the waveform.
<b>Extrema</b>		Superimposes the signal received at all the elements of the array over the signal selected by the Beam No. control.

## 5 Obtaining a C-Scan using RapidScan

The display shows live data from the wheel probe when online. Updating of the data is continuous when not scanning. During scanning, the A-scan window is updated as new data is collected and will not change if the probe is stationary. When offline, select the displayed A-scan by clicking or dragging the right mouse button on the C-scan when in A-B-C or A-T-B view.

There are several different types of rectification:



RF shows the raw digitised signal.



Positive half wave displays the positive data and discards the negative half.



Negative half wave displays just the negative data (inverted).



Full wave rectified displays the “absolute” amplitude, i.e. positive and negative data displayed together as a positive signal.

Figure 32 shows an A-scan view along with its menu settings.



**Figure 32: The A-Scan View and Menu**

To obtain an A-scan, set the **Delay** to zero and the **Gain** to 50dB in **A-scan** menu. The gain can be adjusted by dragging the line on the extreme left of the A-scan window up and down as well as using the Gain control.

Apply gentle pressure to the wheel probe until both the red guide wheels are in contact with the test sample. In sub-menu 1 of the Settings menu, adjust

the **P. Zero** setting to ensure that the interface echo is clearly on the screen with the wheel probe pressed. Note that the **P.Zero** (Probe Zero) assumes the velocity of water equals 1500 m/s.

Set the default velocity (**Mat. Vel.**) to the value for the material being tested, or a close approximation in the case of mixed material specimens. The **Range** should now be set a little larger than the specimen thickness ensuring both front face and back face echoes are visible. The **Gain** should be adjusted in order to observe the back face echo clearly. If desired the **Delay** function can be used to start the A-scan deeper in the structure.













Increasing the pulser repetition frequency (**P.R.F.** in the A-scan menu) can increase the achievable C scanning speed. However, if this parameter is set too high then ghost echoes will appear on the A-scan trace.

The **Delay** and **Range** of the A-scan determine the maximum Pulser Repetition Frequency. A deeper scan will require longer time for the data to be captured, so in order to obtain high scanning speeds, ensure that the **Range** is not set to capture A-scan data that is not wanted.

Ghost echoes are not generated from the test structure. They are decaying signals from the last time a signal was transmitted from that part of the array. These ghost echoes can be identified by adjusting the Pulser Repetition Frequency. If any echoes move along the A-scan due to this adjustment then the Pulser Repetition Frequency has been set too high. If ghost echoes are present then you should first check that the **Ping-Pong** setting in the Settings menu (under sub-menu 2) is turned on, as this will allow higher repetition rates. Then the Pulser Repetition Frequency should be decreased until ghost echoes no longer appear on the A-scan display.

### 5.3. Implementing TCG

Use the TCG menu in RapidScan to apply a TCG curve to an A-scan signal.

Control Title	Ctrl. Image	Description
Gain		The baseline gain of the instrument.
Log		Apply a logarithmic curve.
Custom		Apply a custom curve.
Off		Do not apply a curve, i.e. use baseline gain.
Interface		Enable interface triggering for curve.
Gradient		The gradient of a logarithmic curve, in decibels per metre or decibels per inch.
Convert		Convert logarithmic curve to custom curve.
Point		Select a point on a custom curve.
Add P.		Add point; add a new point to a custom curve.
Rem. P.		Remove point; remove the selected custom curve point.
Depth		The depth of the selected custom curve point, in millimetres or inches.
D. Gain		The delta gain of the selected custom curve point, in decibels.

#### 5.3.1. Applying a Logarithmic TCG Curve



Figure 33: Logarithmic TCG Mode Menu

A logarithmic TCG curve has two properties that are user configurable; the base gain at the start of the curve and the gradient of the curve. Use the Gain control to configure the gain at the start of the curve and the Gradient control to configure the gradient of the curve. A logarithmic curve can be converted into a custom curve (see section 5.3.3).

### 5.3.2. Applying a Custom TCG Curve



**Figure 34: Custom TCG Mode Menu**

A custom TCG curve is defined by two or more points joined together by straight lines. Each point has two properties that are user configurable; the depth of the point and the delta gain of the point. Use the Depth control to change the depth of the point and the D. Gain control to change the delta gain of the point. In an A-scan, a small circular handle on the custom TCG curve indicates a point. The properties of a point are changed by dragging a handle using the mouse. The properties of two connected points are changed together by dragging the line connecting their handles using the left mouse button.

A point on a TCG curve is at the same depth or deeper than points previous along the curve and at the same depth or shallower than points next along the curve. The delta gain property of a point is a change in gain with respect to the base gain. Changing the base gain translates the whole TCG curve in the vertical direction.

### 5.3.3. Converting a Logarithmic Curve to a Custom Curve

A useful TCG curve can be produced by starting with an approximate logarithmic curve and using the curve conversion function to convert it to a custom curve. The properties of the points on the custom curve can then be adjusted to produce a curve with the required gain characteristics. Use the Add P. button in the Custom menu to specify the required number of points on the custom curve before creating the approximate logarithmic curve.

After a logarithmic TCG curve is converted to a custom curve, the delta gain property of a point on the curve may be such that the point's handle is not visible on the A-scan. In this case, the Depth and D. Gain controls are used to change the custom point properties.

### 5.3.4. Delaying TCG Using the Interface Gate



When the Interface setting is enabled, TCG is not applied to the A-scan signal until the depth at which the interface gate is triggered. Before the trigger point, the baseline gain is applied to the A-scan signal. If the interface gate is not triggered, no TCG is applied and the baseline gain is applied to the entire A-scan signal. This may result in an unexpected loss of signal amplitude, which could lead to gates not being triggered.

### 5.4. Setting up Gates for a Basic C-Scan







The Gates menu is split into two sub-menus. Sub-menu 1 contains all the configuration options for fixed width gates. Sub-menu 2 only contains settings for variable width gates.

#### 5.4.1. Gates Sub-Menu 1



Figure 35: Gates Menu 1

Control Title	Ctrl. Image	Description
Gate		The gate currently being edited (Interface, Gate 1, etc). A colour bar displays beside the gate control is the colour that represents the colour display of that gate in A-scan window.
Active		Turns the currently selected gate on or off
Lock Vel.		Lock velocity; locks the individual velocities of all the gates to the material velocity ( <b>Mat. Vel.</b> ) setting in the A-Scan menu. If this button is not set, each gate may have a different material velocity.
Auto Regate		Apply software gating automatically when a gates setting is changed.
Regate		Perform software gating using the current gate settings.
Velocity		Adjusts the gate velocity, in metres per second or inches per microsecond. This is disabled if Lock Vel. is used.
Trig. By		Triggered by; the feature or gate to which the current gate's start position is measured relative to. The Abs. choice represents time zero for the A-scan.
Start		The start position of the current gate based on its velocity (mm or inches), relative to the feature selected by <b>Trig. By</b> .
Width		The gate width of the current gate based on its velocity. <b>width</b> is read-only if the gate is variable width.

<b>Threshold</b>		The threshold of the current gate as a percentage of full screen height.
<b>Amp. P.</b>		Amplitude peak; the waveform peak to measure for amplitude: <b>Largest</b> , <b>Peak 1</b> , .. <b>Peak 14</b> , <b>Peak Last</b> .
<b>T.o.F.P.</b>		Time of flight peak; the waveform peak to measure for depth (Time Of Flight): <b>Largest</b> , <b>Peak 1</b> , .. <b>Peak 14</b> , <b>Peak Last</b> .
<b>+ve/-ve/R.F.</b>		The polarity of the gate: RF; Positive; or Negative. The controls in this column are rotating radio buttons, click on them to move through the possible values.
<b>Peak</b>		The feature of the depth peak to measure to: <b>Peak</b> ; <b>Lead. Fl.</b> (leading flank); <b>Trail Fl.</b> (trailing flank).
<b>Level</b>		The method of triggering the gate: Edge or Level.

The coloured bar to the right of the Gate control has the same colour as the gate in the A-scan window.

### 5.4.2. Mouse Actions

It is possible to change the start, width and threshold of a gate by using the mouse directly on the A-scan.

As the mouse moves towards the centre of a gate, the cursor changes to a hand and circles appear at either end of the gate. Clicking and holding the left mouse button whilst moving the mouse up and down moves the gate up and down. The **Threshold** changes as the gate moves. On releasing the button, the gate in the dialog switches to show the values of the changed gate. This adjusts the threshold without altering the depth or width of the gate.

As the mouse moves towards the start of a gate, the cursor changes to a hand and a single circle appears at the start of the gate. Clicking and holding the left mouse button whilst moving the mouse left and right moves the gate left and right. The **start** changes as the gate moves. This adjusts the depth without altering the width or threshold of the gate.

As the mouse moves towards the end of a gate, the cursor changes to a hand and a single circle appears at the end of the gate. Clicking and holding the left mouse button drags the end of the gate left and right. The **width** changes as the gate moves. This adjusts the size of a gate without changing its depth or threshold.

### 5.4.3. Configuring Gates

The first gate to set up is the interface gate, sometimes called the reference gate. This gate is used to define the position of the front face echo of the test piece (the outer edge of the tyre), removing the effects of small changes in the top surface shape measurements. Figure 36 shows a correctly configured interface gate.

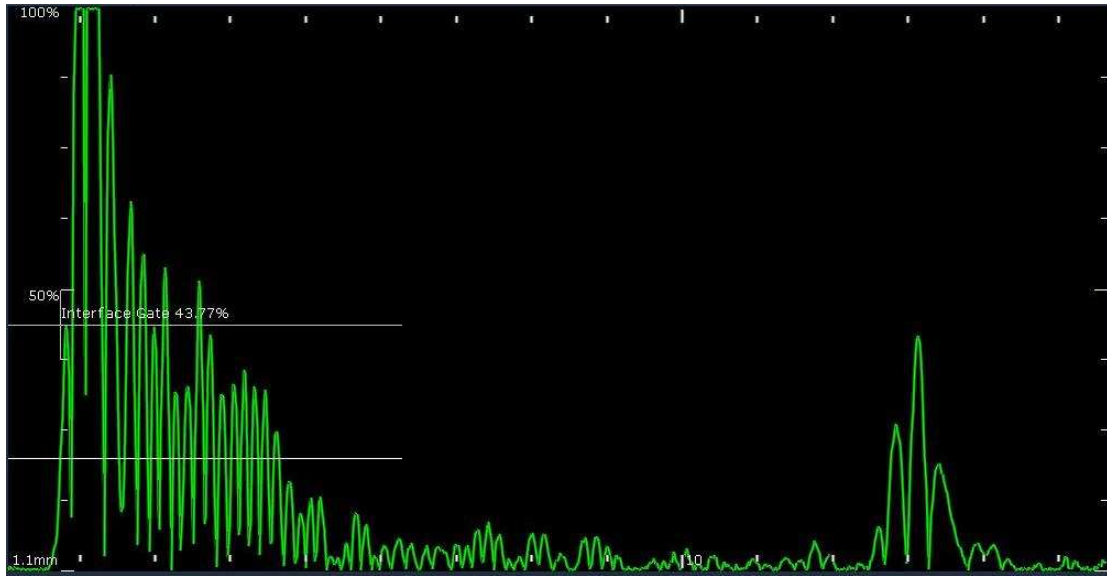


Figure 36: Example of Correct Interface Gate Configuration

In **Gate**, select **Interface**. **Start** should be set to zero and the **width** of the gate should be set such that it incorporates the entire front face echo, with a little extra in case of large variations in surface shape. Activating **Extrema** provides a useful check, showing where signals occur across the full width of the array. It is important to press the wheel probe firmly onto the test piece to obtain the scanning front face position.

Adjust the **Threshold** such that the signal always rises above it, or the gate will not identify a signal. For the interface gate a value of 20% is generally satisfactory, unless large adjustments are made using TCG, see section 3.6.

If the A-scan rectification is set to RF then it is possible to change the polarity of a gate. This can enable the observation of phase reversals and can help to remove spurious echoes from interfering with the measurements from the gate.

### 5.4.4. Configuring Measurement Gates

A C-scan represents the trigger position of measurement gates. To set up a measurement gate click the **Active** button on the **Gates** menu for the gate you wish to turn on. Measurement gates should be **Trig. By** another gate, more often than not this will be set to **Interface**, such that the gate's

location will be relative to the front face of the test piece. Other **Trig. By** options include **Absolute** (the left hand side of the display), or when several gates exist, previous gates can be used.

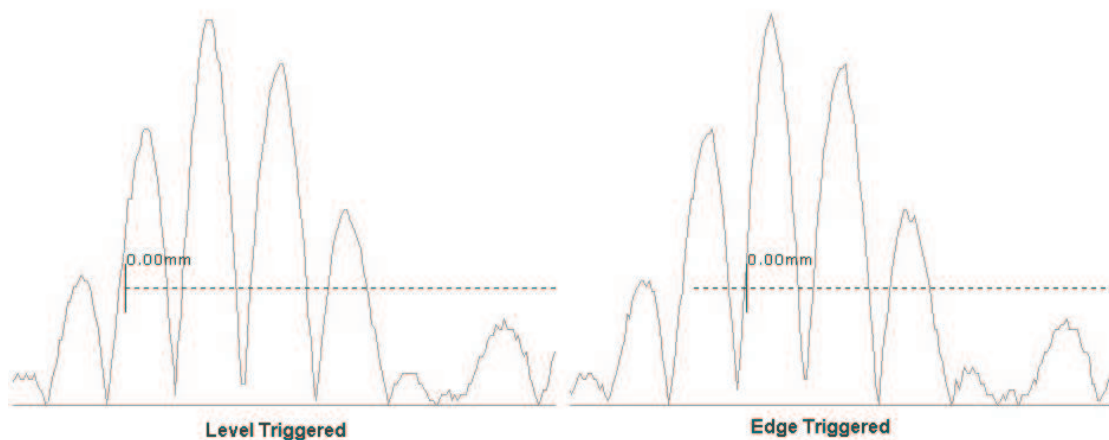
Set the **velocity** to the velocity of the material under test. If the test piece is homogeneous then use the **Lock Vel.** button to set all gate velocity values to the default velocity (**Mat. Vel.** in the A-scan menu). In the case of mixed materials, it may be desirable to set individual velocities for each layer to enable accurate depth measurements.

The **start**, **width** and **Threshold** of the current gate should be set such that the desired feature is encompassed.

To select which features a measurement gate will record, the amplitude peak (**Amp. P.**), depth peak (**T.o.F. P.**) and depth feature can be modified. The amplitude peak will normally be set to the **Largest** peak recorded within the gate. The depth (time of flight) peak will normally be either the **Largest** or **1st** peak within the gate although other options are available.

The depth feature setting determines which part of the specified depth peak measures the depth. Measuring to the flank of a peak is often more accurate than measuring to the summit. Options are available for measuring to the leading flank (**Lead. Fl.**), trailing flank (**Trail. Fl.**) and the highest point on the peak (**Peak**).

Measurement gates may be either level or edge triggered, as illustrated by Figure 37. Selecting **Level** means that the gate will trigger if a signal exists within the gate with amplitude above the gate threshold. Selecting **Edge**, the gate will only trigger after the signal amplitude has risen from below the threshold value to above it. In general similar results will be achieved using either setting, but for near surface detects **Edge** triggering may miss echoes that are very close to the interface echo. The interface gate is always **Level** triggered.



**Figure 37: Level and Edge Triggering**

## 5 Obtaining a C-Scan using RapidScan

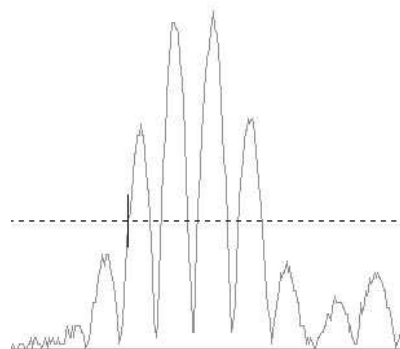
---

A gate has now been set that will follow the profile of the top surface and enable the taking of depth measurements relative to this reference position.

It is now possible to perform a C-scan for the current gate settings. Additional gates can be set up such that one scan can generate several C-scan images. Other gates can trigger these additional gates, this being particularly useful for monitoring the thickness of internal layers. For layered structures of acoustically different materials, sequential gates can be set to trigger from the echoes at each interface with the correct layer velocities set for each gate. This enables the monitoring of actual depths rather than just using a composite velocity. There are a maximum of eight gates available. The examples below illustrate the different gating possibilities.

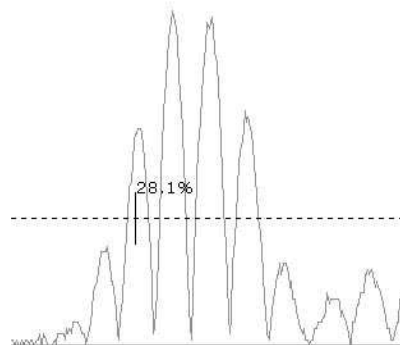
### 1st Peak, Leading Flank:

The first instance that the signal within the gate is above the gate threshold



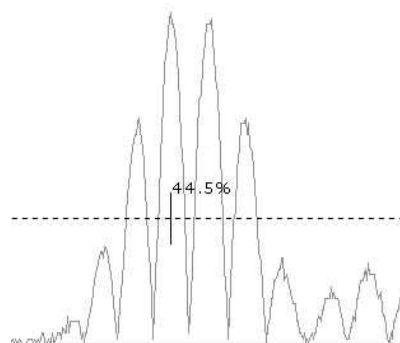
### 1st Peak, Peak:

The first peak of the signal within the gate above the gate threshold



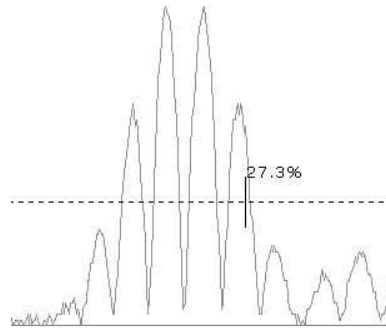
### Largest Peak, Peak:

The largest peak of the signal within the gate above the gate threshold



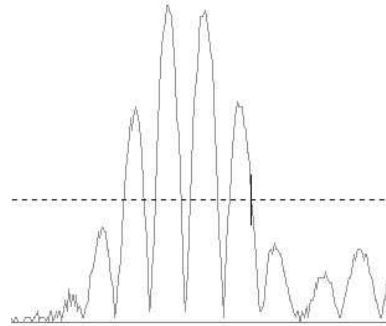
Last Peak, Peak:

The last peak of the signal within the gate above the gate threshold



Last Peak, Trailing Flank:

The last instance that the signal within the gate is above the gate threshold



### 5.4.5. Software Gating

A C-scan contains gated A-scan data. The RapidScan hardware calculates the gated data during the scanning process. The A-scan data can be used to recreate a C-scan by processing the gates in software. There are some subtle differences in the results of the hardware and software gating algorithms because it is not possible for the hardware gating to look back in time in an A-Scan.

If **Auto Regate** is set, software gating is immediately applied post scanning. With **Auto Regate**, one second after gate settings have finished changing, the software gating algorithm will re-gate the C-scan. Software gating can take a significant time to perform on a large scan. It is therefore possible to disable the automatic software gating by turning **Auto Regate** off. Pressing the **Regate** button performs a software re-gate on demand, independently of the state of **Auto Regate**.

### 5.4.6. Gates Sub-Menu 2: Variable Width Gates

Variable width gates allow a gate's end position to be set relative to another gate. For example, using gate 1 for measurement and setting gate 2 to the back wall, gate 1 may be set to variable width, finishing a specified amount before gate 2's trigger position. Figure 38 shows the settings that configure a variable width gate.

## 5 Obtaining a C-Scan using RapidScan

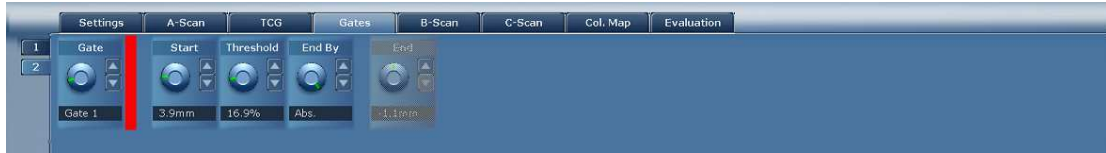







Figure 38: Menu 2: Variable Width Gates

The controls below configure the gates:

Control Title	Ctrl. Image	Description
<b>Gate</b>		The gate currently being edited, mirrored from <b>Menu 1</b>
<b>Start</b>		The gate <b>start</b> , mirrored from <b>Menu 1</b>
<b>Threshold</b>		The gate <b>Threshold</b> , mirrored from <b>Menu 1</b>
<b>End By</b>		The selected edited gate's end is set relative to this gate. If this control is set to <b>Abs</b> , the selected gate is fixed width. If this control is set to another gate, the <b>width</b> control in <b>Menu 1</b> is read-only.
<b>End</b>		The distance before the <b>End By</b> gate's trigger position that the selected gate will end. If <b>End By</b> is set to <b>Abs</b> , the <b>End</b> control is read only.

Variable width gating only works correctly when software gating a C-scan. When in online live mode, the width of the gate is calculated and fed back to the width parameter of the gate. Whilst taking the live scan, all samples use the same width. Once the scan has been completed, it is re-gated in software, with the width of gate one calculated appropriately for each sample.















### 5.5. Adjusting the B-Scan

The B-scan menu has the **Gain** and **Range** controls “mirrored” from the A-scan menu. The user can quickly adjust the settings they need without swapping between the various menus of the system. The B-scan menu also has controls to alter the display of the B-scan, as shown in Figure 39.



Figure 39: The B-Scan Menu

Control Title	Ctrl. Image	Description
<b>Gain</b>		Sets the A-scan and B-scan gain, in decibels.
<b>Range</b>		Sets the A-scan and B-scan range, in millimetres or inches.
<b>Pan L/R</b>		Pan left and right; moves the view left or right within the B-scan.
<b>Pan U/D</b>		Pan up and down; moves the view up or down within the B-scan.
<b>Zoom</b>		Zooms the view within the B-scan.
<b>Asp. Rat.</b>		Aspect ratio; sets the aspect ratio of the B-scan.
<b>Fit</b>		Fits the screen view in B-scan window.
<b>Lock to C</b>		Synchronise pan and zoom view of B-scan and C-scan.
<b>Manual</b>		Manual adjustment which enables the <b>Pan L/R</b> , <b>Pan U/D</b> , <b>Zoom</b> and <b>Asp. Rat.</b> controls.
<b>Position</b>		Specifies the currently selected B-scan in the C-scan.

<b>Sync.</b>		Synchronise the gate trigger positions across each B-scan.
<b>Gate No.</b>		Sets the gate for synchronisation.

### 5.5.1. B-Scan Synchronisation

The Sync. function can be used to remove artefacts caused by inconsistent transducer coupling when scanning. These can be caused by varying the pressure on the wheel probe handle, scanning curved substrates or other conditions. The synchronisation function effectively shifts each A-scan in time within each B-scan such that the chosen gate triggers at exactly the same depth.

Figure 40 shows a B-scan without synchronisation active. This is an exaggerated example to show the contrast to Figure 41, which shows the effect of synchronisation on the same B-scan.

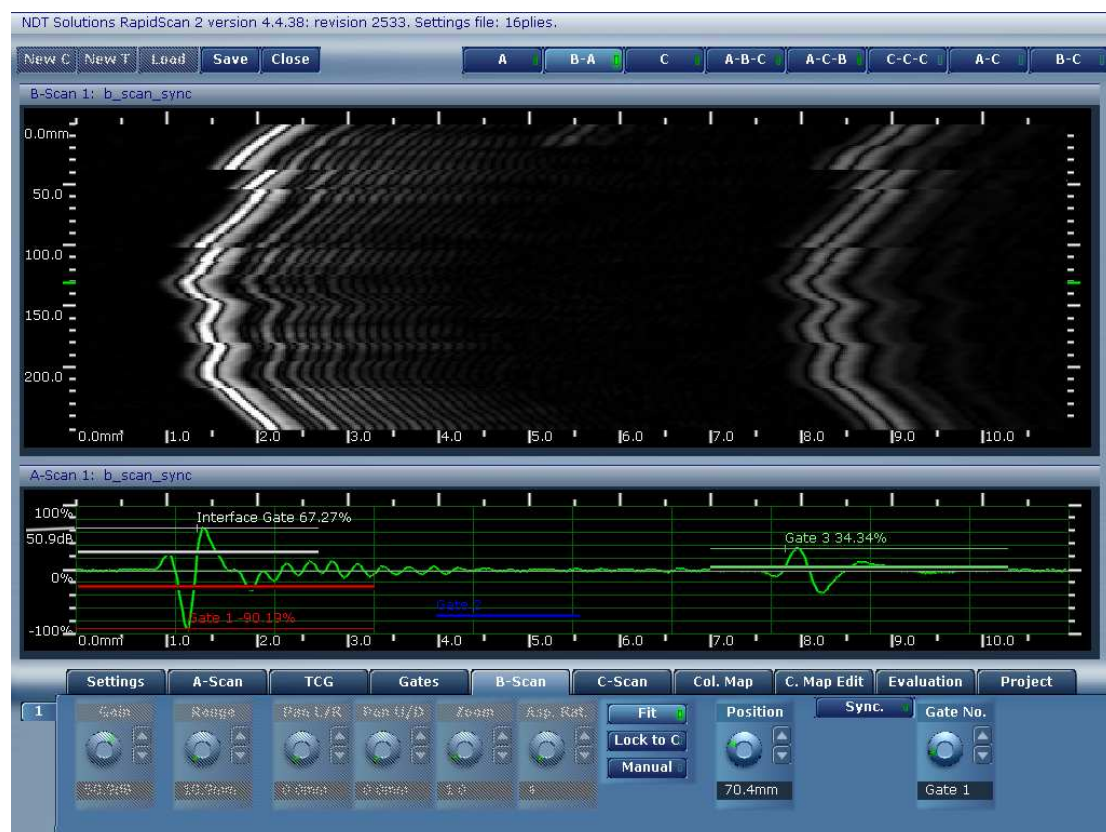
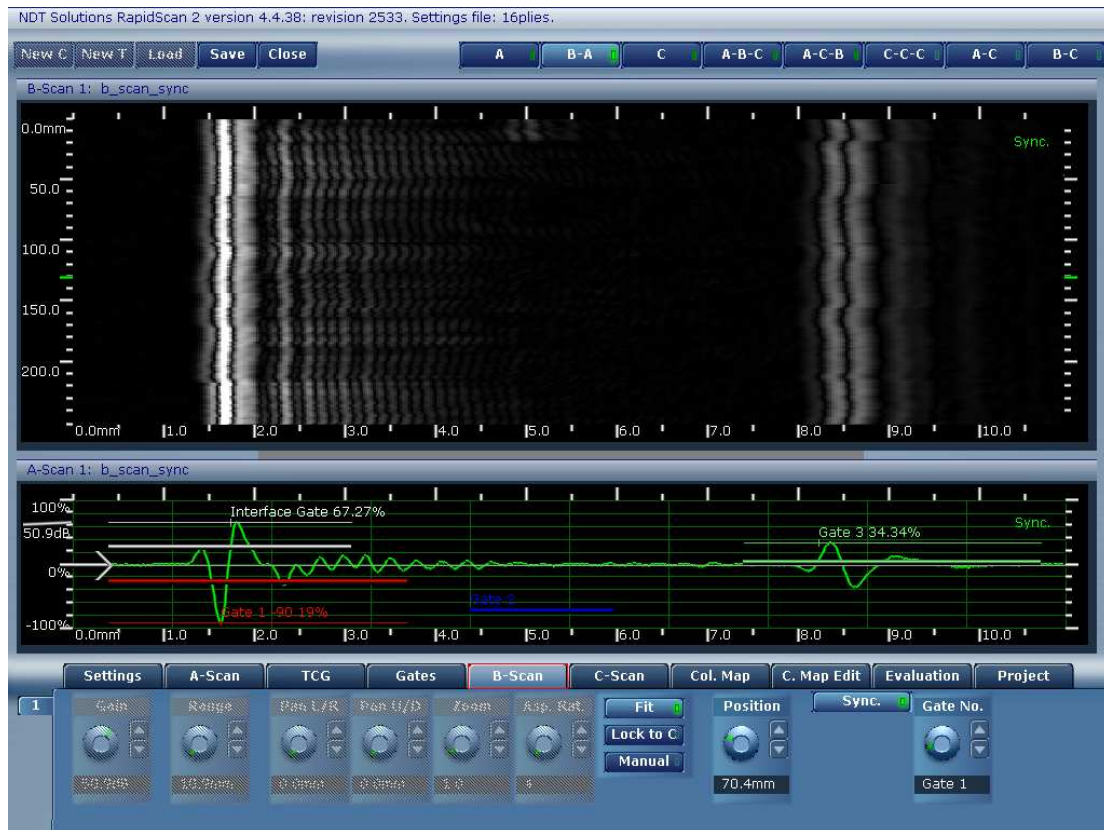


Figure 40: No B-Scan Synchronisation Active

## 5 Obtaining a C-Scan using RapidScan



**Figure 41: B-Scan Synchronisation Activated**

Note that the position of the A-scan in time has been shifted in Figure 41 and this is shown by the arrow pointing to the right on the left-hand side of the A-scan display.









### 5.6. Performing a C-Scan

Figure 42 illustrates the controls of the sub-menu 1 of C-Scan menu. When online, this menu configures the scan to capture. Scans are captured by using the **Go** button on the left. After capturing a scan, the RapidScan goes offline and shows the captured scan.

When offline, read-only controls display the settings used to create the scan. Additional controls determine the display of the C-scan.



Figure 42: The Sub-Menu 1 of C-Scan Menu

Control Title	Ctrl. Image	Description
Go		Start capturing a C-scan.
Pause		Pause the C-scan capture.
Length		The length of the scan.
Pitch Y		C-scan resolution across array.
Pitch X		C-scan resolution in scan direction.
Zoom		Zooms the C-scan views.
Pan L/R		Pan left and right; moves the views left or right within the C-scan.
Pan U/D		Pan up and down; moves the view up or down within the C-scan.












<b>Asp. Rat.</b>		Aspect ratio; sets the aspect ratio of the C-scan view.
<b>Stre.</b>		The Stretch and <b>Fit</b> buttons are used to automatically adjust the <b>Zoom</b> , <b>Pan</b> and <b>Asp. Rat.</b> so that the C-scan fills the available window space. All <b>Fit</b> controls set <b>Pan L/R</b> and <b>Pan U/D</b> to zero. <b>Stretch</b> adjusts the <b>Zoom</b> , <b>Pan</b> and <b>Asp. Rat.</b> so the entire C-scan fills the entire window. This is likely to result in an aspect ratio not equal to one.
<b>Fit</b>		Sets the <b>Asp. Rat.</b> to one and adjusts the zoom so that all the scan fits into the window.
<b>Fit X</b>		Sets the <b>Asp. Rat.</b> to one and adjusts the zoom so that the X direction of the scan fills the entire window. The Y direction of the scan will either have a gap at the bottom, or the bottom of the scan will be cropped.
<b>Fit Y</b>		Sets the <b>Asp. Rat.</b> to one and adjusts the zoom so that the Y direction of the scan fills the entire window.
<b>Auto Co</b>		Automatically fits the colour-map range to the data after collecting a C-scan.
<b>C-1..C-4</b>		Selects which scan the following controls operate on. These buttons also select which scan is shown in the top window if it is not possible to display all four scans in the currently selected view.
<b>Gate No.</b>		Selects which gate generates the scan. When offline, the scan is re-drawn using the newly selected gate.
<b>Rel. To.</b>		Selects whether the scan is representing absolute gate measurements or a calculation of one gate relative to another. A time of flight C-scan should always show the difference between two gates, rather than the absolute position of a gate.
<b>Amp</b>		Selects the scan represents amplitude data.
<b>ToF</b>		Selects the scan represents time of flight data.

Figure 43 below shows the original image changes by using Stre. and Fit X functions. The original C-scan view was created using the Fit Y function.



## 5 Obtaining a C-Scan using RapidScan

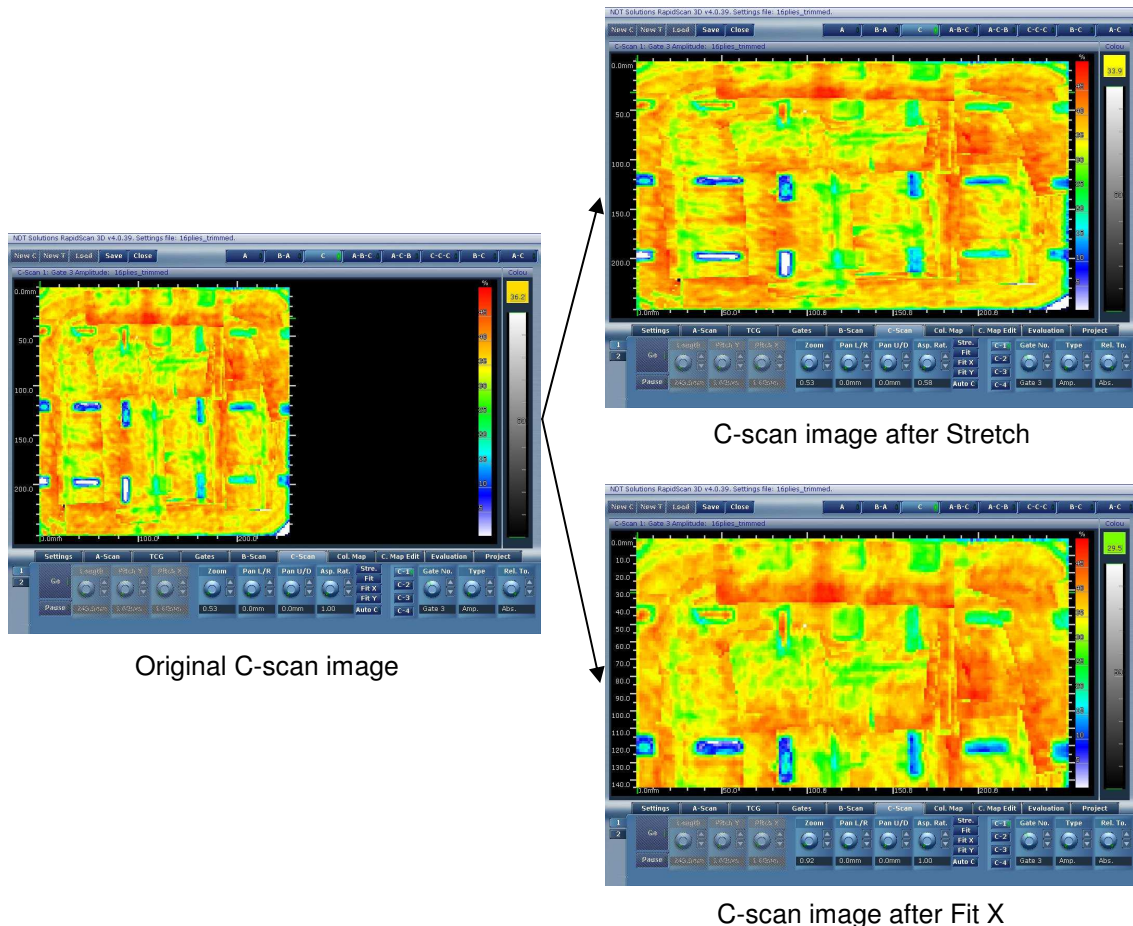


Figure 43: C-scan image effect after stretch and fit

### 5.6.1. C-Scan Views

There may be up-to four C-scans displayed from a single set of A-scans. In the **C-C-C-C** view, the four C-scans are displayed one on top of the other. Pressing the **C-1...C-4** buttons allows changes to the gates making up each of these scans.

In the **A-B-C** view, only one C-scan is displayed. Pressing **C-2** means that the C-scan corresponding to the second C-scan in the **C-C-C-C** view is displayed. The user can quickly swap between the four C-scans by clicking on the appropriate **C-** button.

The bar on the far right of each C-scan represents the colour map used to create the scan. In Figure 44, the top scan has been drawn using a colour map that goes from red, through green to blue, where different colours represent different depths in millimetres. The middle window shows an amplitude scan, where the colours range from 0 to 100%.

Green tick marks appear in C-scan (and also B- and T-scan) rulers to indicate the location of the beam shown in the A-scan window (if visible). In a C-scan,

## 5 Obtaining a C-Scan using RapidScan

the tick marks also indicate the position of the B-scan shown in the B-scan window (if visible).

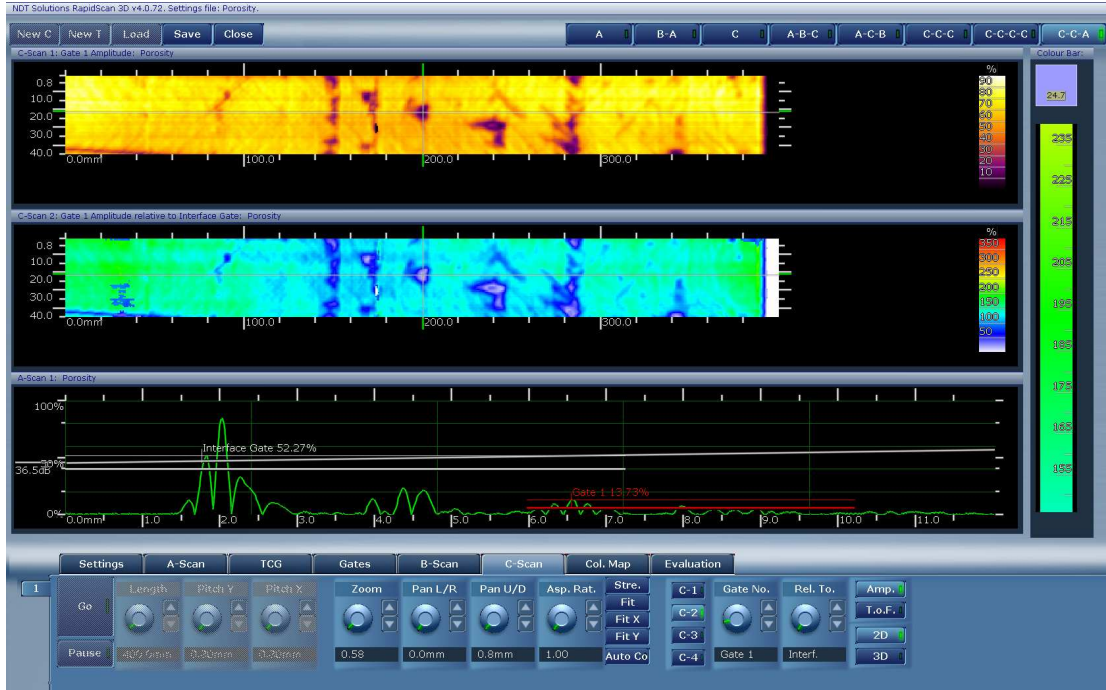


Figure 44: C-C-A View

### 5.6.2. Capturing a C-Scan

Capture a C-scan by pressing the large **Go** button in the C-scan menu. Once pressed, keep the probe steady for a moment while the software prepares to take a scan. During this time, the button displays **wait**. Then roll the probe across the test piece. A red arrow marker underneath the C-scan shows the current position of the wheel probe. After capturing the required length, scanning ceases. The button changes to **wait** whilst the scanned data is processed. The RapidScan then goes offline, displaying the captured scan.

The possible view layouts when scanning are more restrictive than normal. There must be exactly one C-scan window displayed. The C-scan that is displayed in that window can't be changed during scanning or during a pause. The software will grey out inappropriate views when the **Go** button is pressed. If an inappropriate view is selected, the software will automatically switch views to mix before starting a scan.

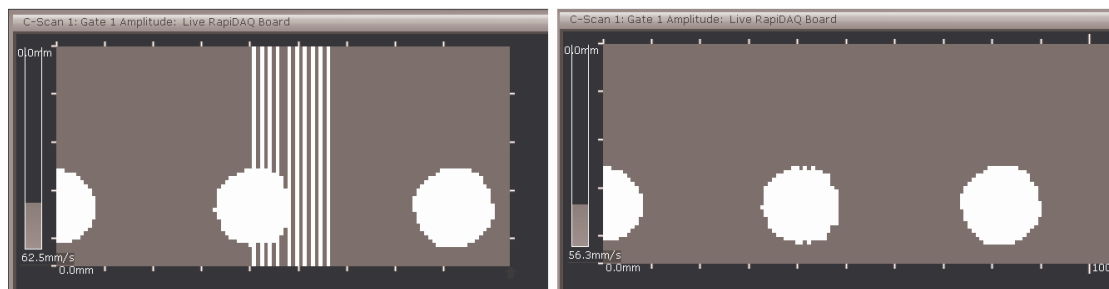
Vertical lines in the C-scan indicate that some data has been lost. A likely cause of this data loss is moving the wheel probe more quickly than the RapidScan can capture data. In these circumstances, move the probe backwards to fill in missed lines and then continue with the scan. In Figure 45, the white vertical lines on the left hand scan were caused by scanning too fast.

## 5 Obtaining a C-Scan using RapidScan

---

If a water pump is connected to a RapidScan unit, the pump is automatically switched on when the software starts capturing c-scan data and switched off when the software stops capturing c-scan data. The Water button in the Settings menu is used to switch the pump on and off when the software is not in c-scan mode. The **Water** button is only shown if the software WinRSSystem.ini file contains the key WaterPumpEnabled with the value "true".

During scanning, the button on the left changes to **stop**. Pressing **stop** during scanning halts the scanning process and the captured data is displayed offline.



**Figure 45: Going Over a C-Scan to Remove Mis-triggers**

The bar on the left of the scan in Figure 45 is the speed indicator. As the wheel probe is moved more rapidly, the bar will turn a red colour indicating the probe is being moved too quickly. This gives a warning that mis-triggers are likely to occur unless the speed is reduced.

### 5.6.3. Saving a C-Scan

Scans are saved from the offline state. Pressing the save button at the top left of the screen brings up the dialog in Figure 46.



## 5 Obtaining a C-Scan using RapidScan

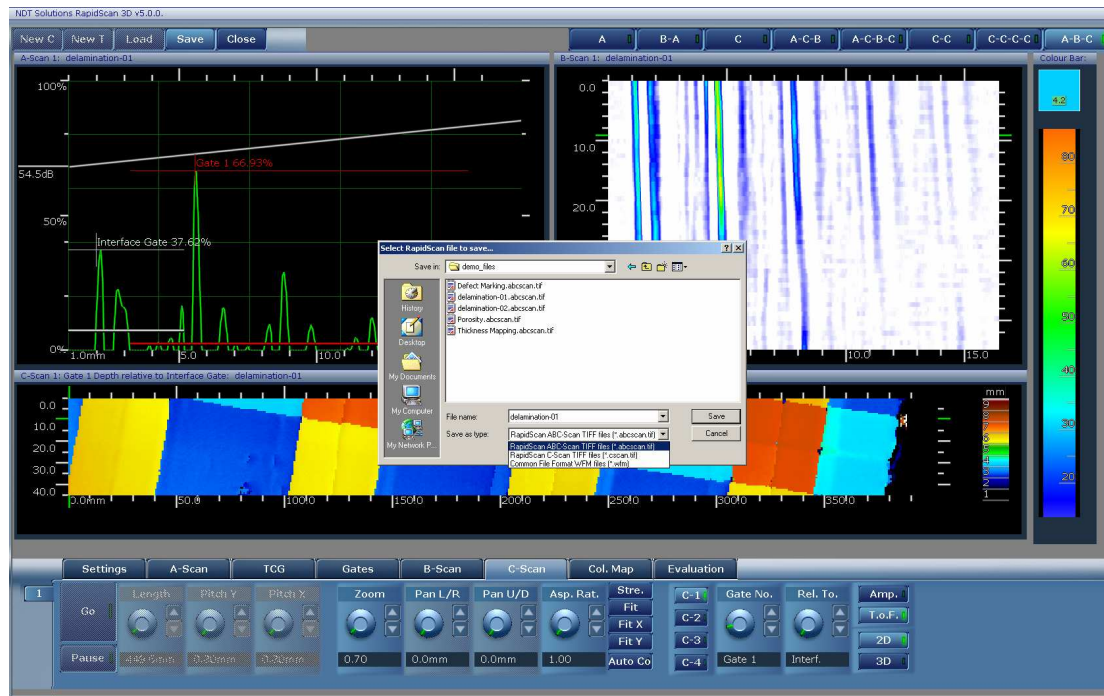


Figure 46: Saving a C-Scan

The location and name of the scan are chosen by using the standard Microsoft Windows save dialog. It is possible to save scan data with or without the raw A-scan data. Saving as type \*.abcscan.tif saves all the A-scan data so that it is possible to inspect individual A-scans at a later date or perform software gating. Saving as type \*.cscan.tif saves only the gated C-scan data. This results in a much smaller file. It is also possible to save a scan as a \*.wfm common file format.

The file name defaults to scan000. After taking a scan, the number is incremented, so the next scan will be scan001. RapidScan remembers the directory where the last was scan saved. If there are already some files in this directory, a name is chosen that is unique, e.g. if there is a scan000 and scan001 in the directory, the new scan will be named scan002. Scans can also be stored and named using letters instead of numbers. e.g. the scan following scan\_a will be called scan\_b. An auto-save function has been introduced to the Rapidscan, if set auto-save enable, system will automatically save the scan file when scan is finished.

### 5.6.4. Using the Wheel Probe Start/Stop Button

It is possible to use the button on the wheel probe handle to start and stop a C-scan. This function is turned on or off by the **WP Button** button in the settings menu.

To start a scan, press and quickly release the button. The RapidScan menu will change to C-scan, and a scan will begin. Now roll the wheel probe forward in the usual manner. To stop a scan mid way, press and hold the wheel probe

button for longer than 1 second. When the button is released, the scan will stop.

Starting a new scan with the wheel probe button is possible when in the offline state following a previous scan. It is therefore possible to take a sequence of scans just by using the wheel probe button.

### 5.6.5. C-Scan Mouse Actions

Clicking and dragging directly on the image in the C-scan window provides a convenient way to view different areas of a scan. The C-scan supports the following mouse actions:

Mouse Action	Description
Left Drag	Move the mouse over the C-scan, press and hold the left button and move the mouse with the left button held down. The C-scan will pan around the window.
Right-Drag / Shift-Drag	In A-B-C view, move the mouse over an area that needs to be examined. Pressing the right mouse button and dragging or holding the shift key and moving the mouse causes the A and B-scan windows to be updated to show the scans under the current mouse position.
Mouse Wheel	Spinning the scroll wheel zooms in or out about the current mouse position on the C-Scan. This only works if the mouse is over the C-scan and the window has been previously selected by clicking within the window.

## 5.7. Applying & Editing the Colour Map

### 5.7.1. Applying the Colour Map

The colour map sub-menu 1 adjusts the colour map for the B-scan, C-scan and T-scan data displays. Figure 47 illustrates the available controls.










Figure 47: The Colour Map Sub-Menu 1

The controls are:

Control Title	Ctrl. Image	Description
B-1, C-1 ...		Selects which scan the controls operate on. These buttons are mirrored to the C-scan C-1 . . C-4 buttons and so also affect which C-scan is displayed or edited. In New C mode,

## 5 Obtaining a C-Scan using RapidScan

		the T-scan button is read-only. In New T mode, only the <b>B-1</b> and <b>T-1</b> buttons are available.
<b>Scheme</b>		Selects the colour map palette to use.
<b>Low</b>		Sets the minimum position of the colour map. Sample points with a value less than the <b>Low</b> setting will display using the under range colour.
<b>High</b>		Sets the maximum position of the colour map. Sample points with a value greater than the <b>High</b> setting will display using the over range colour.
<b>Centre</b>		The mid point of the <b>low</b> and <b>high</b> values. Altering the <b>centre</b> pans the colour map over the data. <b>Low</b> and <b>High</b> are both changed but the difference between them remains the same.
<b>Reset</b>		Automatically sets <b>Low</b> and <b>High</b> to cover the data
<b>Reverse</b>		Reverses the colour palette
<b>Zoom</b>		Zooms the data start and end of the histogram about the <b>Centre</b> position.

The histogram on the right of the menu shows the data from the currently selected scan. This updates in real-time with an online B-scan data source. The height of each line is a logarithmic representation of the data covered by the line. This emphasises small areas of the scan such as defects that have values that differ from the remainder of the scan.

The **zoom** control adjusts how the data is represented in the histogram and does not affect the mapping of the colour map to the scan. A zoom of 1 means that the histogram covers the range of data in the scan. A zoom of less than one allows blank space either side of the data in the scan to be seen. With a zoom of less than 1, the grey background indicates data in the range of the scan and black background data values that are outside the range of data in the scan.

The RapidScan stores four sets of colour map values for every gate value. There is one map for each combination of (amplitude / time of flight) and (absolute / relative). The C-scan and T-scan maps are stored independently of each other.

### 5.7.2. Editing the Colour Map

RapidScan is supplied with several pre-defined colour maps. The **C. Map Edit** menu allows editing of the pre-supplied maps, or creation of further maps, to suit the requirements of an inspection. The **C. Map Edit** menu works in conjunction with the special view shown in Figure 48. The previously selected view is restored when another menu is selected.

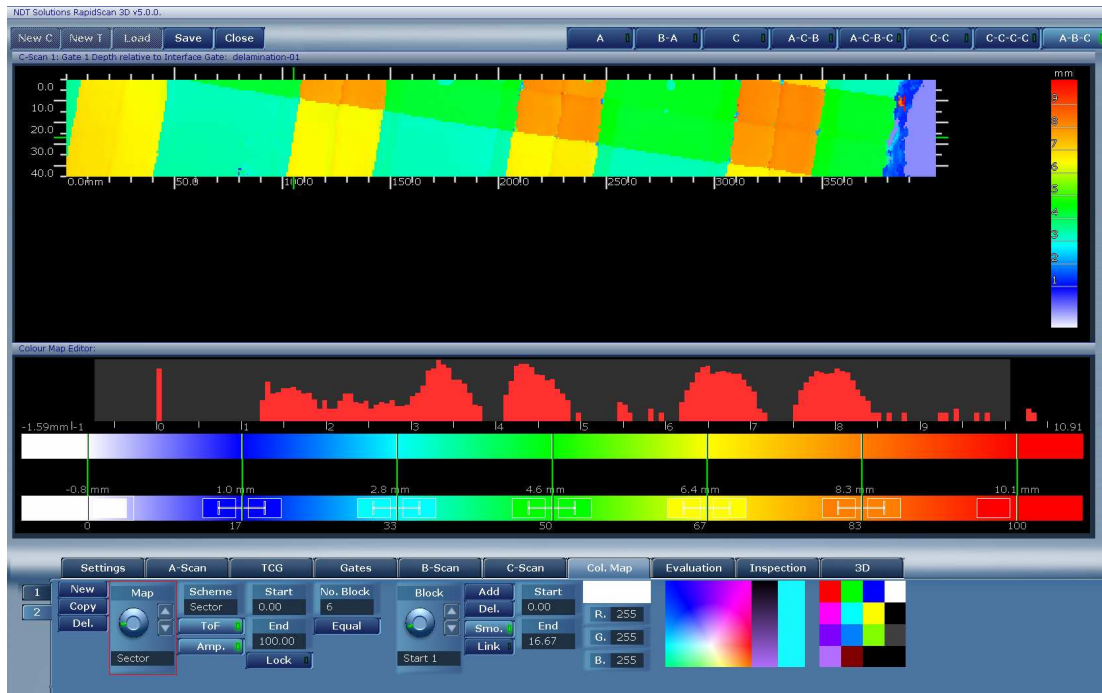


Figure 48: The Colour Map Editor

The top half of the screen shows the currently selected C/T-scan. The effects of changes to the colour map are seen on the scan as the map is changed.

The Colour Map Editor window shows the histogram of the selected scan and two colour bars. The histogram is aligned with the top colour bar. The top colour bar is the actual colour map, drawn to scale. The under range colour is on the left and the over range colour on the right. The bottom colour bar shows the blocks making up the colour map. Each block in the bottom colour bar is drawn with the same width.

#### 5.7.2.1. Applying Colour Maps to Scans

The same colour map may be applied to many different scans. The **High** and **Low** colour map settings of these scans may be different. The same colour map may also be applied to amplitude scans, where **High** and **Low** are percentages, and time of flight scans, where **High** and **Low** are expressed in millimetres. The colour map is therefore defined using its own set of numbers that are unit-less. In Figure 48, the colour map has been defined using

## 5 Obtaining a C-Scan using RapidScan

numbers from 0 to 100. The numbers defining the range of the map are set in the **Start** and **End** edit boxes in the fourth column of the menu.

Figure 48, shows an amplitude C-scan, so the units of the histogram are percentages. The example scan has its colour map **Low** set to 10% and **High** to 90%. These values are used under the histogram and between the two colour bars. The units used to define the colour map are shown under the bottom colour bar. These range from 0...100 and correspond to the 10...90% Low to High thresholds of the scan.

### 5.7.2.2. Blocks and the Colour Map Editor

A colour map is constructed from multiple colour blocks. Every colour map has an under range and over range colour. These are shown on the extreme left and right of the colour bar. The under range colour is applied to points on the scan that are less than the **Low** threshold and the over range colour to points that are above the **High** threshold. In Figure 49, both the under and over range blocks are set to black.

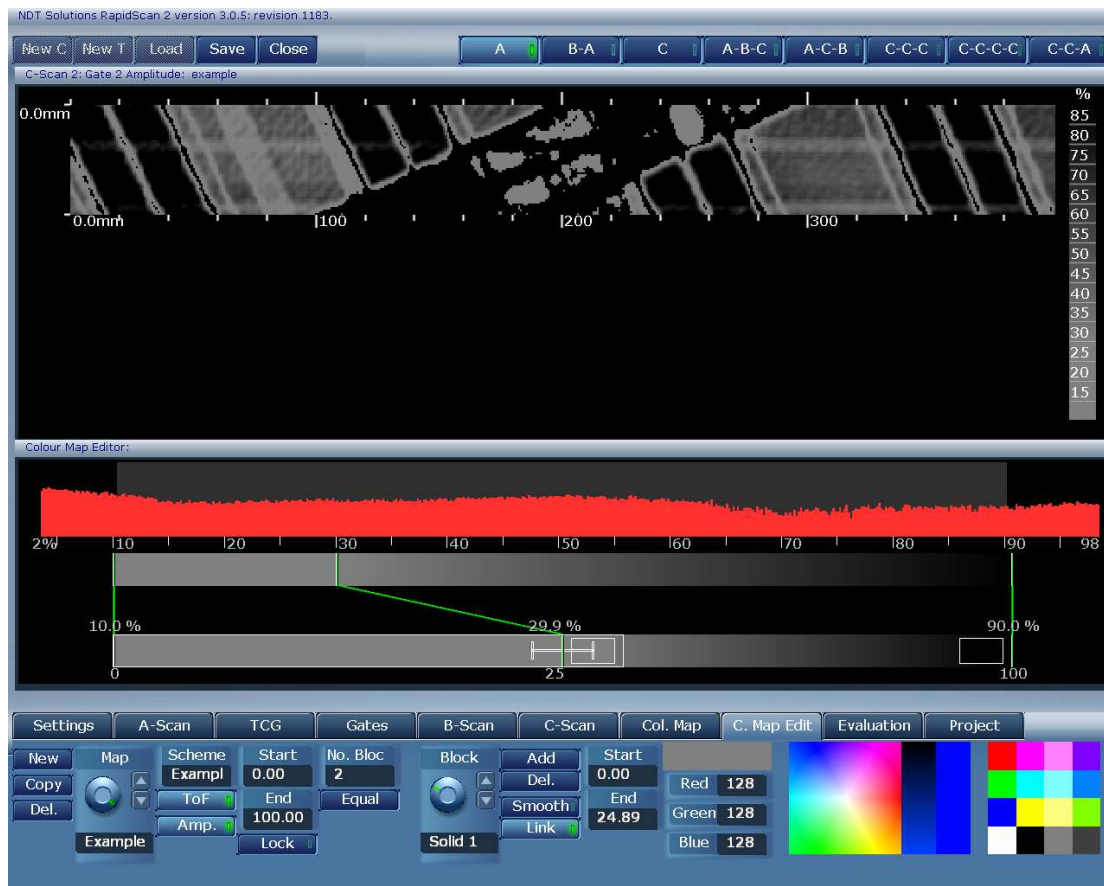


Figure 49: A Solid and a Smooth Block

The colour map that covers the selected data range of the scan is constructed from one or more blocks. These blocks may be **solid**, consisting of a single colour, or **smooth**, covering a range from the block's **start** colour to its **End** colour. In Figure 49, the first block is a **solid** block with a grey colour. The

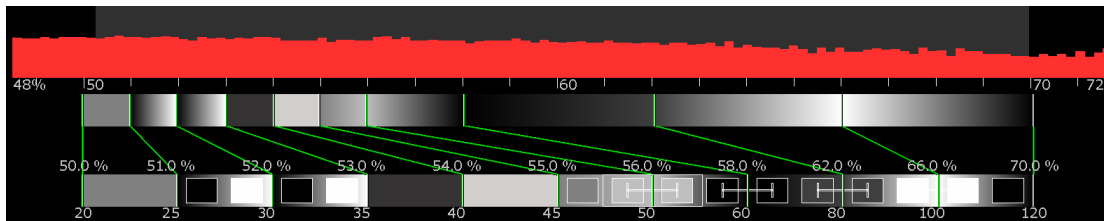


second block is a **smooth** block. Its **start** colour is grey and its **end** colour black. A **smooth** block's **start** and **End** colours are shown in rectangles within the block on the bottom colour bar.

A **smooth** block normally has a **Link** from its start colour to the end colour of the previous block. The white line between the two blocks in Figure 49 indicates that the start of the **smooth** block is linked to the **solid** colour block. If the **solid** colour block's colour is changed, the start of the **smooth** block is automatically changed to match the new **solid** colour.

The **solid** block in Figure 49 takes up 0..25 in the colour map. The **smooth** block takes up 25..100. In the bottom bar, both blocks are drawn with the same size. The top bar is drawn to scale, so the **solid** block is  $\frac{1}{4}$  the size of the **smooth** block. Green lines link the bottom and top blocks so that it is easy to see which block affects which part of the map. The current C-scan has a **Low** of 10% and a **High** of 90%. The **solid** block therefore covers amplitudes from 10..30% and the **smooth** block covers amplitudes from 30..90%.

Figure 50 shows a more complex example with 10 blocks. The C-scan has a low threshold of 50% and a high threshold of 70%. The colour map starts at 20 and ends at 120.



**Figure 50: An Example of 10 Blocks**

The first block is solid grey and covers from 20-25 of the colour map's range. This covers amplitudes in the range 50-51% in the C-scan. A solid block may be used in this way to highlight defects that occur at a particular amplitude or depth.

The next two blocks are **smooth** black to white and are not linked. This gives a smooth graduation within the block but a sharp transition on the block boundary. There then follow two more solid colour blocks.











The remaining five blocks illustrate a more typical use of smoothed blocks, where each block's **start** is linked to the **End** colour of the previous block. The top colour bar illustrates how smooth linked blocks gives a smooth transition between colours.





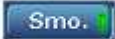


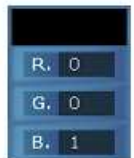
### 5.7.2.3. The Colour Map Editor Menu

Figure 51 illustrates the colour map editor menu.



Figure 51: The C. Map Edit Menu

Control Title	Ctrl. Image	Description
<b>New</b>		Creates a new blank colour map with one block.
<b>Copy</b>		Creates a new map that is a copy of an existing map. This map can then be changed whilst the original map remains unchanged.
<b>Del.</b>		Deletes a colour map.
<b>Map</b>		Shows the map that is currently being edited. Changing this control also changes the <b>scheme</b> used for the viewed scan.
<b>Scheme</b>		Allows the name of the map to be changed. The text at the bottom of the <b>Map</b> control is not editable.
<b>ToF / Amp.</b>		If the <b>ToF</b> button is lit, the map is suitable for Time of Flight scans. If the button is not lit, the map can not be used for Time of Flight scans and will not appear in the list of <b>schemes</b> for amplitude scans.
<b>Amp.</b>		Indicates that the map is suitable for use with Amplitude scans. Every colour map must have one or both of <b>ToF</b> or <b>Amp.</b> selected.
<b>Start/ End</b>		The <b>start</b> and <b>End</b> controls in the fourth column set the start and end of the colour map that is currently being edited.
<b>Lock</b>		If <b>Lock</b> is selected, all scans which use the colour map being edited have their <b>High</b> and <b>Low</b> thresholds tied to the <b>start</b> and <b>End</b> of the map. The <b>High</b> and <b>Low</b> controls in the Colour Map menu are read-only when a locked map is selected. This allows a map to be defined where for example 5mm is always represented by red and 7mm by blue. A locked map is used with either amplitude or Time of Flight, not both.
<b>No. Block</b>		The number of blocks making up the map. Editing this number causes blocks to be added or deleted.

<b>Equal</b>		Arrange all the blocks to be of equal width.
<b>Block</b>		The <b>Block</b> control is used to select the block or part of block to edit. It will show <b>UndrRng</b> when editing the under range colour on the far left. <b>solid 1</b> means the first block is being edited and that this block is solid. <b>start 2</b> means that the start colour of the second block is being edited. <b>End 2</b> means the end colour of the second block is being edited. Smooth blocks have different start and end colours <b>OvrRng</b> means that the over range colour at the far right of the map is being edited.
<b>Add</b>		Adds a new block. The currently selected block is split into two.
<b>Del.</b>		Deletes the currently selected block. The block to the left is normally expanded to take over the current block's range in the map.
<b>Smooth</b>		Determines whether a block is solid with one colour or smooth with separate start and end colours.
<b>Link</b>		If <b>Link</b> is set, the start colour of this block is linked to the end colour of the previous block. Changing either this block's start colour or the previous block's end colour results in both blocks changing. Only <b>smooth</b> blocks can be linked.
<b>Start/End</b>		The Start / End in column eight show the start and end values of the selected block. The values are within the bounds of the Start and End values of the map, in column four.
<b>Red, Green, Blue</b>		The Red, Green and Blue colour components that make up the colour of the currently selected block. Colours may also be selected by using the colour swatch on the right of the menu.

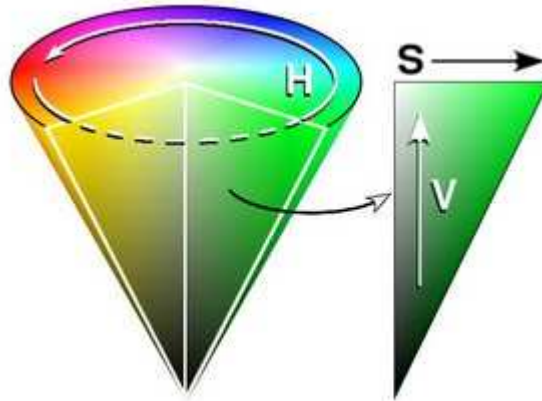
#### 5.7.2.4. Selecting Colours

It is sometimes difficult to choose a colour by entering its Red, Green and Blue values directly into the edit box. RapidScan implements the HSV (Hue, Saturation, Value) model as a more natural way to select a particular colour. The HSV (Hue, Saturation, Value) model, defines a colour space in terms of three constituent components:

- Hue, the colour type (such as red, blue, or yellow).



- Saturation, the "vibrancy" of the colour: the lower the saturation of a colour, the more "greyness" is present and the more faded the colour will appear.
- Value, the brightness of the colour:



**Figure 52: HSV Colour Space as a Cone**

RapidScan uses the model of a cone to visualise the HSV values, illustrated in Figure 52. In this representation, the hue is depicted as a three-dimensional conical formation of the colour wheel. The saturation is represented by the distance from the centre of a circular cross-section of the cone, and the value is the distance from the pointed end of the cone.

RapidScan uses the multi-coloured square to the left of Figure 53 to represent a cross section through the cone. The different hues are spread out around the edge of the square. Saturation ranges to full at the edge to none (white) at centre of the square. The value is obtained by a separate rectangle to the right of the square. This rectangle changes depending on the hue and saturation picked from the square. For example, Figure 53 shows a crimson colour that has been selected by clicking on the appropriate area of the square. The rectangle to the right of the square has been updated to show shades from black to the selected colour. A colour has been chosen by clicking on this rectangle. The selected colour is shown on the second rectangle further right.



**Figure 53: Selecting a Colour in the Colour-Map Editor**

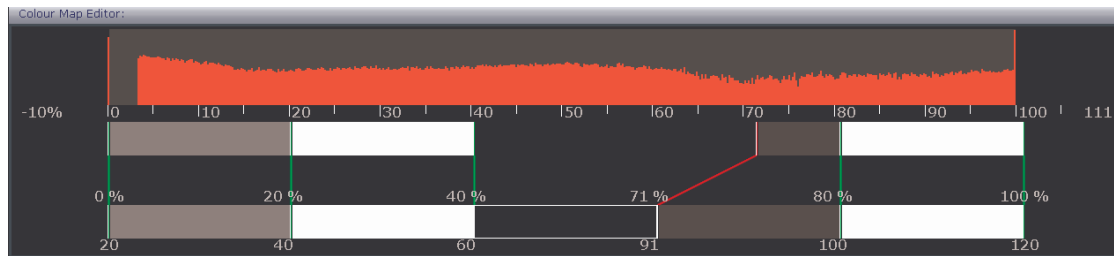
It is possible to pick any colour by first choosing the hue and saturation from the square then the intensity from the rectangle. To get shades of grey, click on the white area in the centre of the square. The rectangle then updates to show all the shades of grey from black through to white.

The area on the far right of the display contains sixteen of the most useful colours. The colours are immediately selected by a normal left click.

### 5.7.2.5. Mouse Actions on the Colour Map Editor

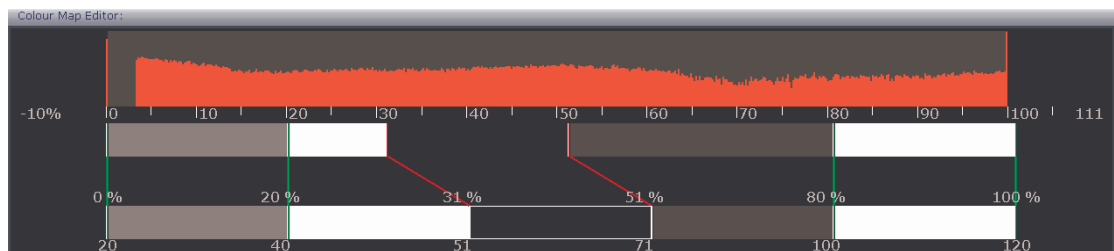
Clicking on either the top or bottom colour map bar updates the Block to the one that has been clicked on. A new colour may be rapidly assigned to a Block by clicking on the block then on the required colour.

The Start and End of a block may be rapidly adjusted using left mouse drags on the top bar. If the mouse is moved close to one end of a block, the green line close to the mouse turns red and the cursor changes to a double arrow. Holding down the left mouse button and dragging then allows the start / end position to be changed. This is illustrated in Figure 54.



**Figure 54: Adjusting the Boundary Between two Blocks**

If the mouse is moved to the centre of a block, the green lines linking the top and bottom blocks turn red. The cursor changes to a hand. Dragging the mouse with the left button held down allows the block to be shifted left or right in the top bar, as in Figure 55.



**Figure 55: Moving a Block**

### 5.7.2.6. The Factory Default Maps

There are several factory default maps supplied with RapidScan. These maps can not be permanently deleted. If a factory default map is deleted, it will be restored to the factory defaults the next time the application is started.

If a factory default map is edited, the changes to the map will be remembered. To discard these edits, delete the map and restart the application. It is advised

that the factory default maps are copied and then edited rather than being edited directly.

### 5.8. Drag-able Colour Bar

The colour bar window shows the colour bar of the C-scan that currently has focus. It supports various mouse actions that are used to alter the colour map low, high, centre, and zoom values. The mouse actions are similar to those for manipulating other objects in the program, such as gates. The low and high thresholds of the colour map are altered by dragging the corresponding line on the colour bar with the mouse. Both are altered simultaneously by dragging in the area between the two lines. The zoom is changed using the mouse wheel, in a similar way to zooming the C or T-scan views. Double-clicking on the colour bar resets the view so that 1/3 of the window contains the colour bar.

Figure 56 shows the effect of dragging the colour bar on the resulting C-scan. The colour-map updates in real-time and this can be used to identify features in the C-scan more easily than when viewed using a static colour-map.

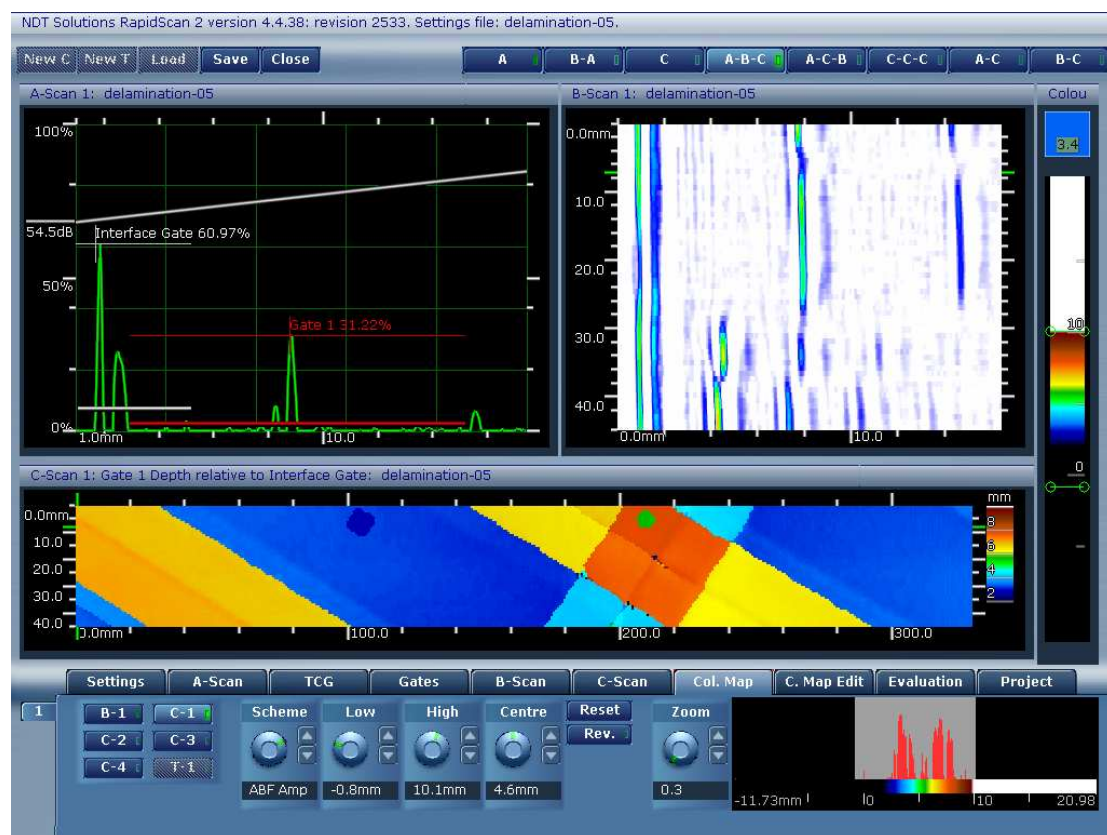


Figure 56: Original C-Scan Colour-Map

## 5 Obtaining a C-Scan using RapidScan

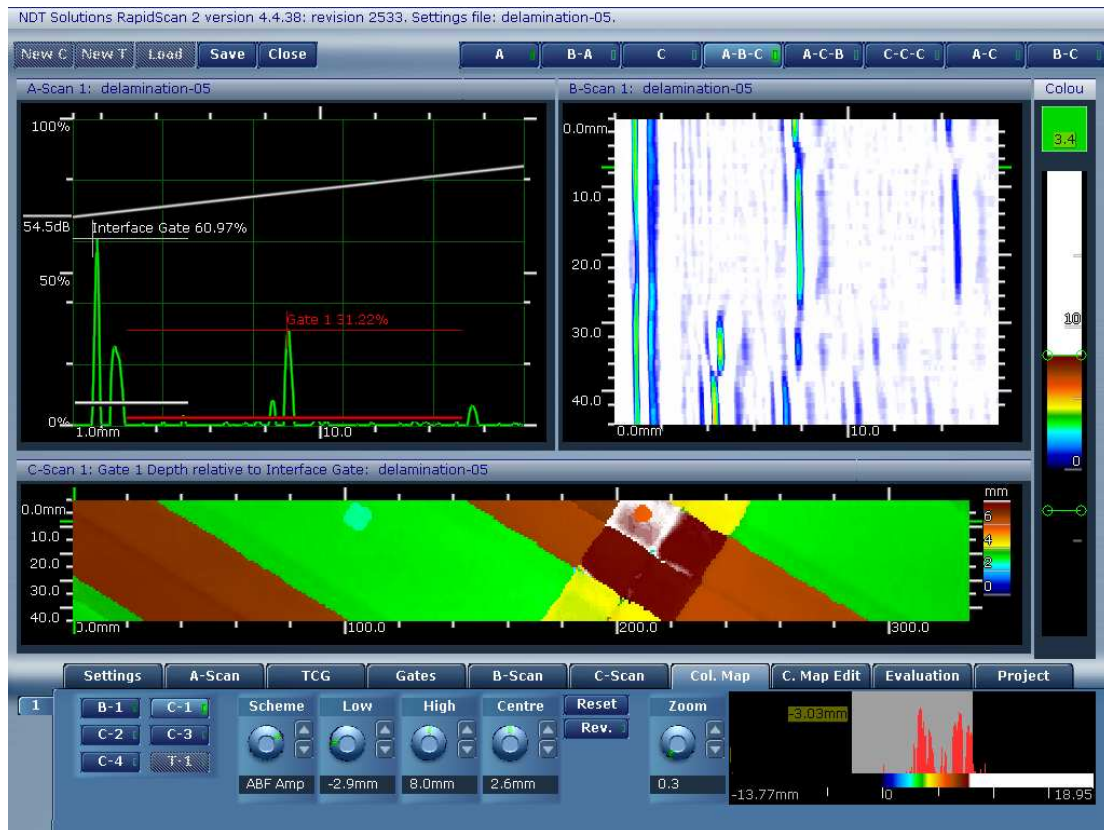


Figure 57: Effect of Dragging Colour-Bar Downwards

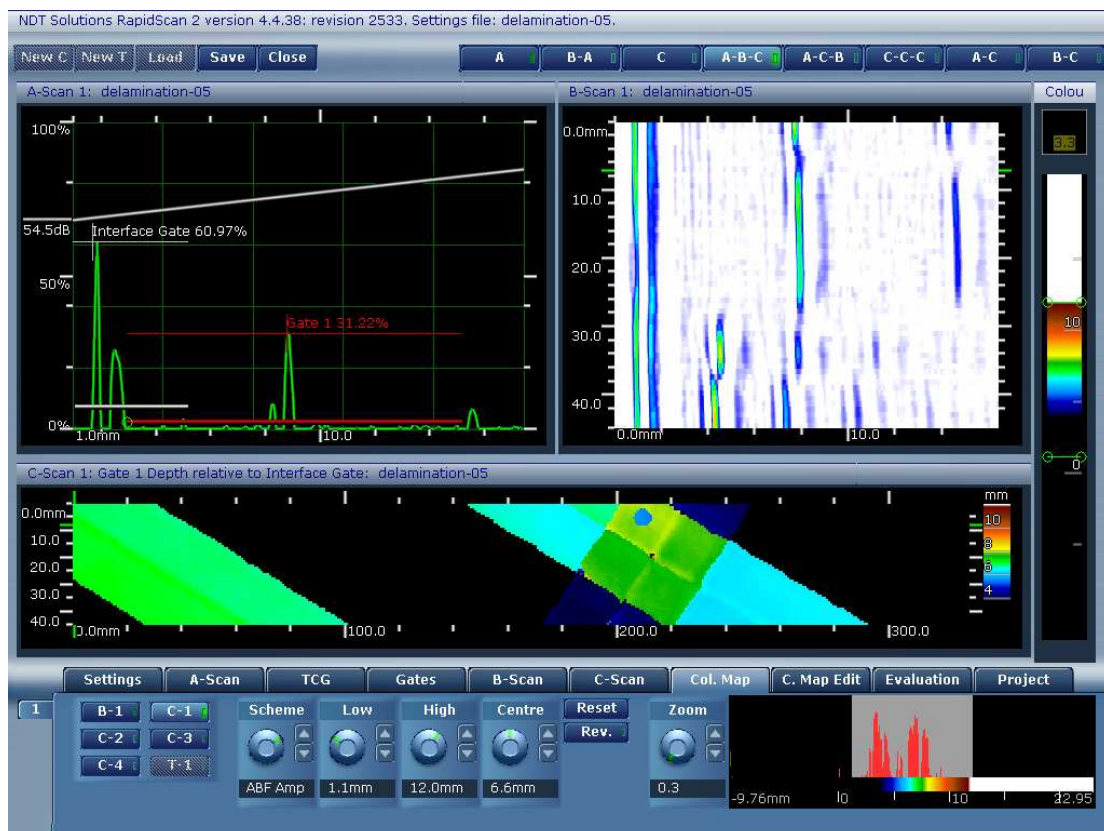


Figure 58: Effect of Dragging Colour-Bar Upwards

The square at the top of the colour bar window has the same colour as the C-scan sample under the mouse cursor. This is equivalent to the colour square in the Evaluation menu. The square can display more than one sample by clicking on the C-scan, holding down the CTRL key and rotating the mouse wheel to zoom in and out.

### **5.9. Marking the Defects**

An important part of the scan evaluation process is the marking of defects, and other features, on the scan. The section of the RapidScan manual describes the fundamentals of constructing and manipulating geometric objects that represent the defect.

#### **5.9.1. Basic Behaviour of Defect Objects**

Each of the distinct defect object types are created using a similar set of mouse actions, performed on the scan itself. The common approach is based on left clicking, to define a point, and dragging and releasing, or “rubber-banding”, to define another point. For example, with the case of a rectangle, the first click defines a corner and the drag and release point defines the diagonally opposite corner. This is the default behaviour from systems such as Microsoft Windows. The remaining defect object types operate in a similar manner to the rectangle and is explained in more detail in the next section of the manual.

Once a defect object has been created on the C-scan, it can be re-sized, re-arranged or re-positioned using simple mouse actions. The points that compose the defect object can be moved by left-dragging the mouse on the particular point. The user can see which point will be affected as a small highlighting circle is drawn around the point if the mouse cursor is sufficiently close. The whole defect primitive can be moved, without changing the spatial relationship between the points, by left-dragging the mouse on a part of the object which is not a point: such as the line between two points. When the mouse cursor is sufficiently close to the object, each of its points will have the highlighting circle: if the user left-drag the mouse then the whole object will move. Finally, the defect object can be rotated by holding down the Ctrl key and dragging the mouse when each of the points have highlighted circles. The centre of rotation is around the mouse cursor position.

By default, each defect object displays some text at its centre point. The output value depends on the type of object and is its primary physical characteristic. For example, those objects with area, such as rectangle and ellipse, display their area but object without area, such as a line, display their length.

It can be seen that drawing a defect on one C-scan results in the defect object being displayed on all of the C-scans.

Each of the defect objects can be associated with some text, often describing the feature. When objects are first created, they are given a unique name (as the defect note) by the program that can help a user identify defect primitives without having to manually provide names for them. The names generated by the application are made up of two parts; a word identifying the type of the primitive (e.g. “Ellipse”) followed by an integral value (e.g. “12”).










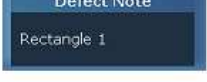










## 5.9.2. Evaluation Sub-Menu 1




sub-Menu 1 of the evaluation section of RapidScan is shown in Figure 59.



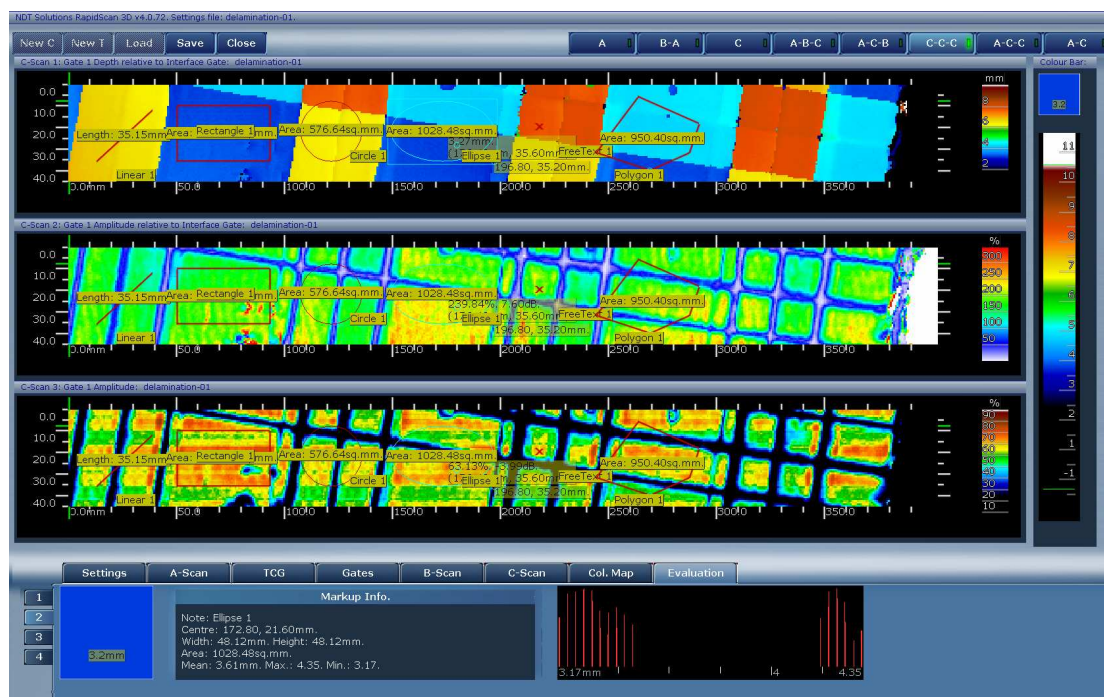
Figure 59: Evaluation Tools Sub-Menu 1

Control Title	Ctrl. Image	Description
Linear		Selects line defect type.
Rectangle		Selects rectangle defect type.
Circle		Selects circle defect type.
Ellipse		Selects the ellipse defect type.
FreeText		Selects the free text annotation defect type.
Polygon		Selects the polygon defect type.
Draw		Enabled defect drawing.
Delete		Selects defect delete mode.
Delete All		Selects defect delete all mode.
Defect Note		Allows text to be assigned to a defect.
Save Defect		Save the defect to the file.
Samp. Area/ Geom. Area		Sample area/geometric area: the type of area displayed for each defect.
Tool-Tip		Enabled C-scan tool-tip.
Floating		Selects where C-scan tool-tip information is displayed.
Cross-Hair		Enables C-scan cursor crosshair.
Verbose		Activates the extra defect information mode.
Snap		Enable\disable the snap function to the grid capture.
Defect		Selects the colour of defect shapes.

## 5 Obtaining a C-Scan using RapidScan

<b>Crosshair</b>		Selects the colour of the crosshair.
<b>Tool-Tip</b>		Selects the colour of the tool tip.
<b>Label</b>		Selects the colour of C-scan labels.

The **Linear**, **Rectangle**, **Circle**, **Ellipse**, **FreeText**, and **Polygon** radio-buttons allow the currently selected defect object type to be defined. Draw must be enabled before defects can be drawn. Examples of each of these types are shown in Figure 60.



**Figure 60: Example of Five Types of Defect Objects**

The **Linear** tool is the simplest defect object contained within RapidScan. It is a basic line between two feature points. It can be created by selecting in **Linear** in Figure 59 and left clicking the mouse on the scan at the desired start point and dragging the mouse to the appropriate end point of the line.

The **Rectangle** defect object allows measurements of rectangular features to be made. It can be created by selecting in **Rectangle** in Figure 59 and left clicking the mouse on the scan at the first desired corner point and dragging the mouse to the appropriate point for the diagonally opposite point.



The **Ellipse** defect object allows measurements of approximately elliptical features to be made. It can be created by selecting in **Ellipse** in Figure 59 and left clicking the mouse on the scan at the first desired centre point and dragging the mouse to the appropriate point which represents the maximum of the major and minor axes of the ellipse.

The **FreeText** object allows annotations to be applied to the scan which are not associated with a particular defect. It can be created by selecting in **FreeText** in Figure 59 and left clicking the mouse on the scan to define the point. Text to be entered into the **Defect Note** edit-box to define the appropriate text.

The **Polygon** defect object allows measurements of arbitrary polygonal regions be made. Unlike the object types already described, the polygon can have an arbitrary number of points. This requires extended mouse actions during their construction and manipulation. This inductive procedure is begun by drawing a line in the same way as for the **Linear** defect object. In summary, a polygon is drawn using the following procedure:

- Press the left mouse button down where you want the first point.
- Keep the left mouse button held down and drag to the second point.
- Release the left mouse button then hold it down again.
- Keep the mouse button held down and drag to the third point.
- Repeat from step 4 until all points are drawn

Once a polygon has been drawn, click on a point with the left mouse button and hold it down to drag it to a new position.

The **Delete** function activates the delete defect indication mode. Click on the defect indication to remove and it will be deleted. The **Delete All** function removes all defect indications after confirming with the user.

The **Defect Note** edit box allows text to be associated with a defect. Selecting a defect object and then typing in the box results in the text being displayed alongside the defect on the C-scan. Figure 60 shows the text "**Ellipse 1**" is associated with an ellipse defect object.

The **Tool-Tip** button activates the tool-tip that appears next to the mouse pointer when it is held still on the C-scan for a short length of time. The tool-tip will remain displayed until the mouse pointer is moved outside of the scan. The tool-tip displays the amplitude (in % and dB) or time-of-flight value for the C-scan sample under the mouse pointer as well as other information, such as the A and B-scan indices.

The **Floating** button changes the position of information associated with A-scan data under the cursor. With **Floating** enabled, the information appears in the tool-tip (providing the **Tool-Tip** button is also enabled). When the button is disabled, the information appears under the C-scan window title bar.

The **Cross-hair** button activates the transparent cross-hair which intersects at the current mouse position.

The **verbose** button activates the high level of defect reporting mode, where more text appears on the C-scan. If **verbose** is off, no text will appear on the scan and the blue box surrounding a C-scan when it is moved will also be hidden.

The Defect, Crosshair, Tool-Tip, and Label dials change the colour of defect primitives, the crosshair, the tool-tip, and C-scan labels respectively.

The **Samp. Area** and **Geom. Area** functions select between the possible algorithms for calculating the area of a defect indication. The **Samp. Area** mode counts the number of C-scan samples whose centre appears within the defect and multiplies this by the area of each sample. Therefore, this is a form of area quantisation and it approaches the real geometric area for finer C-scan resolutions. The **Geom. Area** function calculates the actual geometric area of a defect which is not constrained to be a whole-number multiple of the area of a C-scan sample. The difference between **Samp. Area** and **Geom. Area** is made because in certain evaluation algorithms within RapidScan make use of counting the number of samples within a defect which are above or below a threshold; the sum of this pair of values should be the reported area of the defect but this is not always exactly the case for the **Geom. Area**.

The **save Defect** function allows the portion of C-scan contained within the currently selected defect indication to be saved as a RapidScan C-scan file (with or without A-scan data, if available). Click on the defect indication to save and click on **save Defect** and select a filename.

The **snap** function constrains the location of defect indication points to coincide with the corners of C-scan samples. When this mode is off, the defects can be positioned arbitrarily on the C-scan without snapping to sample corners.

### 5.9.3. Evaluation Sub-Menu 2

Sub-Menu 2 of the evaluation section of RapidScan is shown in Figure 61.



Figure 61: Evaluation Tools Sub-Menu 2

Control Title	Description
Zoom Control (left display window)	Shows a zoomed-in area around the current mouse position
<b>Markup Info.</b>	Displays information for the currently selected defect
Defect Histogram (right display window)	A histogram of the area within the currently selected defect

The zoom control on the left-hand side of Figure 61 shows a magnified version of the scan around the current mouse pointer location. In addition, it also shows the amplitude or time-of-flight value in text form for the C-scan sample. Holding Ctrl and using the mouse wheel alters the size of the region displayed.

The **Defect Info.** text box displays information about the currently selected defect object. The exact information displayed depends on the defect selected defect type. An example for the ellipse type is shown in Figure 59. For those defect types that have non-zero area (rectangle, ellipse, and polygon), some basic statistical functions are applied to the T-scan area within the defect object. These include the mean, maximum, minimum and standard deviation of the C-scan samples. The C-scan used to provide information to these functions is that which was last selected.

The defect histogram control shown in the right-hand side of Figure 59 shows the histogram for the T-scan region within the last selected defect. This only makes sense if the region has non-zero area.

### 5.10. Storing and Printing using the Settings Sub-Menu 1

The settings sub-menu 1 is used for Importing, exporting and printing data. Figure 62 shows the available controls.

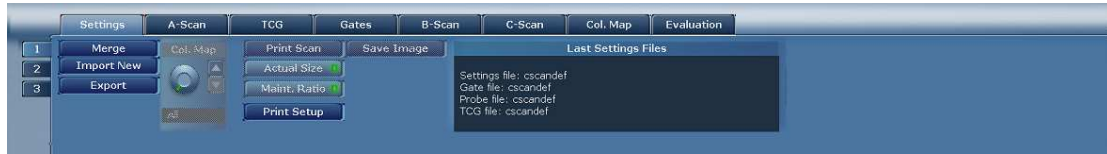





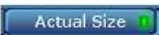






Figure 62: The Settings Sub-Menu 1.

Control Title	Ctrl. Image	Description
Merge		Merge multiple settings files into one file
Import New		Load settings from a file.
Export		Save settings to a file.
Col. Map		Chooses which colour map will be exported. Defaults to All to export all the colour maps in a single file.
Print Scan		Prints the current C or T-scan. Clicking this button displays the standard Windows printer dialog. From here the printer is chosen and printer specific options are selected. The state of the Actual Size and Maint. Ratio buttons control how the scan is printed.
Actual Size		If Actual Size is set, the scan will be printed at actual size, using multiple sheets of paper if necessary. If Actual Size is not set, the scan will be printed on a single sheet of paper.
Maint. Ratio		If Maint. Ratio is selected, the scan will be printed using a unity aspect ratio. If Maint. Ratio is not selected, the scan will be stretched as required to fill a sheet of paper. This button has no effect if Actual Size is selected.
Print Setup		Prints the RapidScan's current settings. Clicking this button displays to standard windows printer dialog, allowing a printer to be selected and printer options to be set. The settings are then printed over several sheets of paper.
Save Image		Saves an image of the focus C-scan or T-scan which includes defects, colour-bar, and other information.

## 5 Obtaining a C-Scan using RapidScan

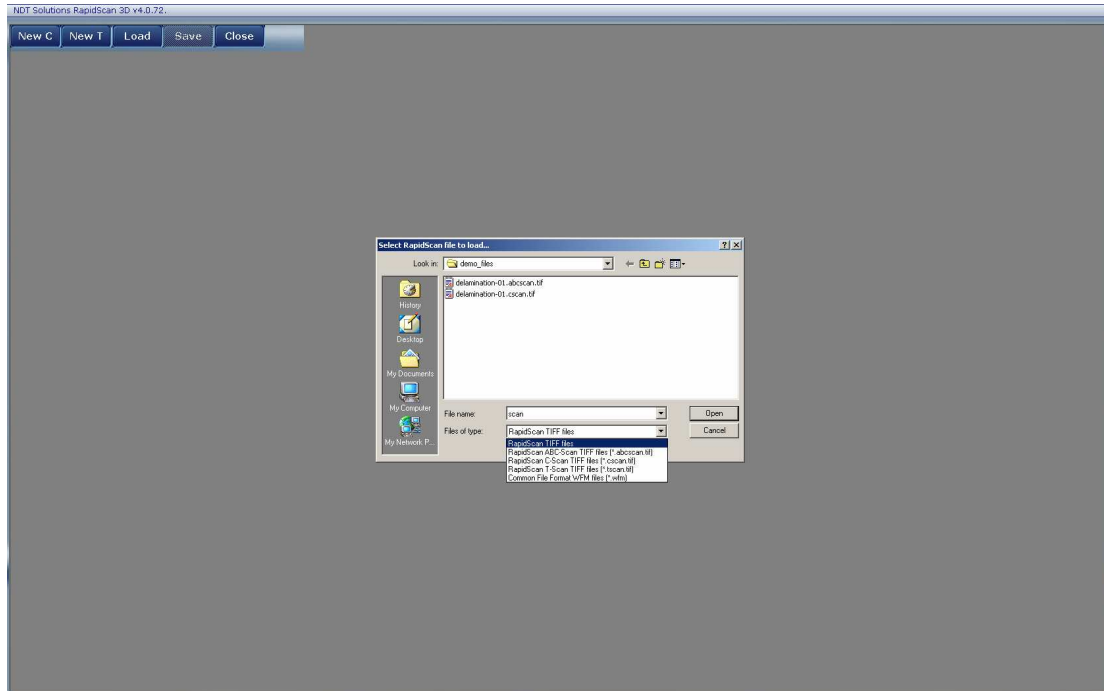
<b>Last Settings File</b>		Contains the name of the settings file(s) that were used to configure the different aspects of the configuration.
---------------------------	---	---

Pressing Ctrl-P on a C or T-scan window with focus prints the scan using the current print setup.

### 5.10.1. Importing and Exporting Data

There are two mechanisms for loading and saving data: the load and save buttons on the top left of the screen and the project menu.

After logging in, the Load button brings up the dialog shown in Figure 63. A previously saved C-scan or T-scan data can be loaded in order to start an off-line evaluation session. The types of file that may be used to create a new session are displayed in Figure 63.

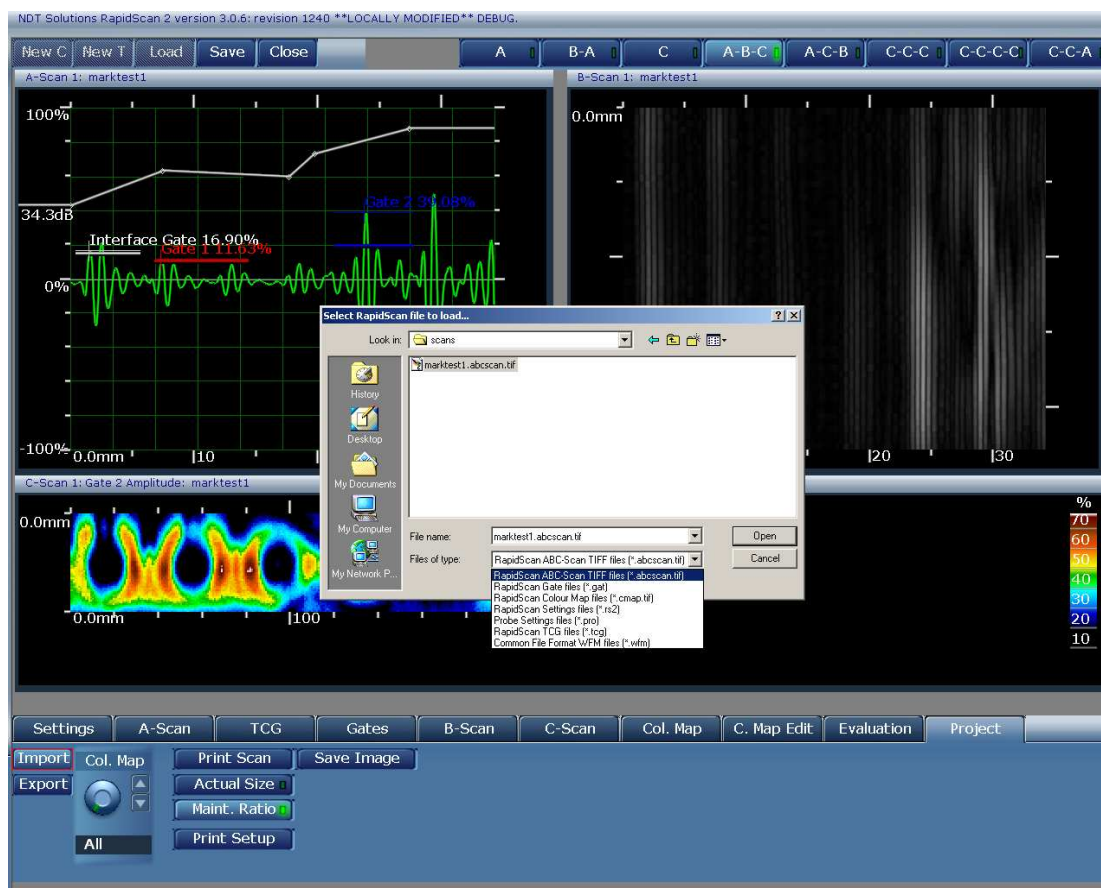


**Figure 63: Loading a File to Start an Off-line Session**

The save button is available when off-line in a C-scan or editing a T-scan to provide a rapid way to save the current set of scans.

Alternatively, data can be imported and exported via the project menu. Import and export can take place during an on-line or an off-line session. Data imported into an online session overwrites the current settings with previously saved settings. Figure 64 shows the types of data that may be imported.

## 5 Obtaining a C-Scan using RapidScan



**Figure 64: Importing Data into an Online Session**

When importing or exporting, the file type determines which data is loaded or saved.

File Type	Description
ABC-scan TIFF files, Common File Format WFM files, C-scan TIFF files,	Importing a previously saved scan will update the settings with the settings used to create the scan. Exporting a scan performs the same action as saving a scan. Exporting scans is only available when offline.
RapidScan Gate files	The gates settings are loaded or saved. When importing, general settings such as the probe delay and range keep their current values. The TCG curve is not changed.
RapidScan Colour Map files	When exporting, the Col. Map control determines which colour map to save. When importing, whatever colour maps were saved in the file are added to the available colour maps. If the file contains colour maps with the same name as those currently available, the colour maps will be replaced with those saved in the file...

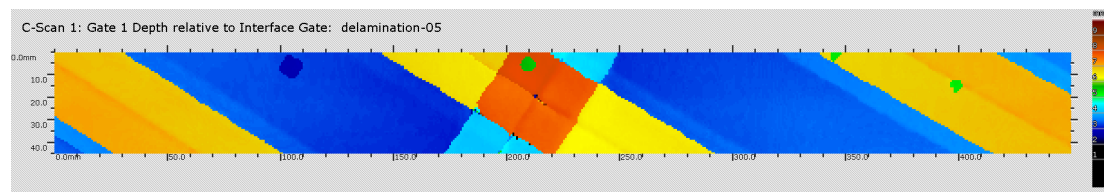
## 5 Obtaining a C-Scan using RapidScan

RapidScan Settings files	All the settings associated with a scan are exported or imported, including gates and TCG values.
Probe Settings files	Only settings concerned with a probe are exported or imported, e.g. the normalisation values.
RapidScan TCG files	The custom TCG curve is loaded or saved.

Images of the C-scan or the T-scan which has focus can be saved using a Shift-Ctrl-I shortcut key-press. The image will be saved as one scan sample per image pixel and will not include defects or other information. This process can also be executed by selecting the Save Image button in the Project dialog.

Images of the C-scan or the T-scan which has focus can also be saved using a Ctrl-I key-press. The image will be up-sampled such that it appears at approximately actual size and will include defects and other information unlike the Ctrl-I shortcut.

Figure 65 & 66 demonstrate the results of both C-scan bitmap saving choices.



**Figure 65: Result of Ctrl-I Save of C-Scan Bitmap Image**



**Figure 66: Result of Ctrl-Shift-I Save of C-Scan Bitmap Image**

### ***5.11. Downloading Data from the RapidScan***

Data can be accessed off RapidScan through connection to a network or by directly linking it to a PC by a crossover network cable. The laptop also contains an 802.11b/g wireless network adapter.

RapidScan uses standard Windows XP networking, accessible through the control panel. This defaults to using a DHCP server to obtain networking configuration. If there is no DHCP server available, contact the network administrator for your site for advice on configuring networking. The RapidScan laptop can be accessed like any normal Windows XP PC, via the Microsoft network neighbourhood.

All C-scans are stored in multipage TIFF format. For C-scans with full A-scan data capture enabled the first pages are the C-scans from all the gates, both Amplitude and Depth. All the B-scans are stored as sequential pages within the TIFF file and can be extracted and manipulated using image viewing software. RapidScan comes with the IrfanView TIFF viewer installed to view these files. The location of saved scans and other settings files is detailed in Chapter 8.



## 6. Creating a T-Scan using RapidScan

The T-scan allows the user to construct a large area map comprising of a number of C-scans. In order to make a new T-scan, close any existing sessions by pressing the **C**lose button, and press **N**ew **T**. A blank T-scan will be created with the default size.









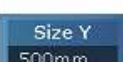

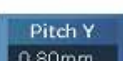

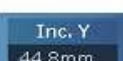
### 6.1. Configuring Fundamental T-Scan Parameters

#### 6.1.1. T-Scan Sub-Menu 1



Figure 67: T-Scan Sub-Menu 1

Control Title	Ctrl. Image	Description
<b>Add</b>		Adds a C-scan file to the T-scan
<b>Delete</b>		Selects delete mode: click on C-scan to remove
<b>Group</b>		Selects group mode: click and drag a rectangle to group C-scans
<b>Ungr.</b>		Selects ungroup mode: click on C-scan group to ungroup
<b>Lock</b>		Selects lock mode: C-scans cannot be moved
<b>Gate No.</b>		Selects the gate number to display
<b>Amp/ToF</b>		Selects the gate metric to display
<b>Rel To.</b>		Selects the relative gate
<b>Zoom</b>		Zooms the T-scan around the top left of display area

<b>Pan L/R</b>		Pans the T-scan left and right
<b>Pan U/D</b>		Pans the T-scan up and down
<b>Asp. Rat.</b>		Selects the aspect ratio of the T-scan
<b>Stretch</b>		Sets aspect ratio such that all the X-axis is displayed and the zoom such that all of the Y-axis is displayed
<b>Fit</b>		Sets the aspect ratio to one and the zoom such that all of the scan is displayed
<b>Fit X</b>		Sets the aspect ratio to one and the zoom such that all of the X-axis is displayed
<b>Fit Y</b>		Sets the aspect ratio to one and the zoom such that all of the Y-axis is displayed
<b>Size X</b>		Sets the X extents of the T-scan canvas
<b>Size Y</b>		Sets the Y extents of the T-scan canvas
<b>Pitch X</b>		Sets the X pitch of the T-scan canvas
<b>Pitch Y</b>		Sets the Y pitch of the T-scan canvas
<b>Inc. X</b>		Sets the X increment to add new C-scans at, relative to top-left of the last added C-scan
<b>Inc. Y</b>		Sets the Y increment to add new C-scans at, relative to top-left of the last added C-scan

The **Add** and **Delete** buttons control which C-scan files are included in the T-scan. **Add** allows a RapidScan abcsan.tif or cscan.tif file to be added to the T-scan. The file will be automatically added at the offset defined by **Inc. X** and **Inc. Y** relative to the top-left of the last C-scan file which was added. Combined with the multi-selection feature of the file selector dialog, this feature allows a number of C-scans to be added without the need for significant re-positioning. The **Delete** button selects delete mode, this allows a C-scan file to be removed by clicking on its image. Once a C-scan file has been deleted, delete mode is unselected.

The **Group**, **Un Gr.** and **Lock** buttons control the movement behaviour of a number of C-scans. **Group** selects group mode, which allows a selection

rectangle to be drawn on the T-scan. Any C-scans which have some of their area within the selection rectangle are included in the new group. Once a number of C-scans are contained within a group, they can be moved and rotated as a single entity. This allows C-scan files which have been relatively positioned correctly to be moved without losing their spatial relationships. The **Un Gr.** button selects ungroup mode which allows the relationship between the C-scans in an existing group to be removed by clicking on a C-scan within the group. When selected, the **Lock** button prevents any C-scans within the T-scan from being moved. This is useful when each of the C-scans have been positioned correctly as it prevents the user moving them by mistake.

The **Gate No.**, **Amp/ToF**, and **Rel. To** controls define which T-scan is currently viewed. The parameters which these controls represent are equivalent to those for the C-scan program mode. The **Gate No.** control defines the primary gate to view, the **Amp/ToF** radio-buttons select the gate metric to view, and the **Rel. To** control defines the relative gate for the view (this may be **Abs** if a relative view is not required).

The **Zoom**, **Pan L/R**, **Pan U/D** and **Asp. Rat.** controls define which area of the T-scan is currently viewed. These have the same meaning as for the C-scan mode already described. Using the mouse on the T-scan canvas can be used to define the **Zoom**, **Pan L/R**, **Pan U/D** controls. The zoom is controlled by the mouse wheel (if present). The T-scan view must have mouse focus and then using the mouse wheel allows the zoom to be increased or decreased around the current mouse position. The pan of the T-scan view can be set by dragging the left mouse button on a blank area of the T-scan canvas. The pan can also be set by dragging the middle mouse button anywhere on the T-scan (including on C-scans).

The **Fit** series of buttons allows the user to easily select canonical views which include either or both of the X-axis and Y-axis of the T-scan. These behave in the same way as has been described in the C-scan section of this document.













The **size x** and **size y** controls allow the user to specify the size of the T-scan canvas. These can be changed even after C-scan files have been added, providing that the new size does not result in a C-scan disappearing from the T-scan.

The **Pitch x** and **Pitch y** controls the size of the T-scan samples along the X and Y-axis respectively (in other words, the T-scan resolution). This cannot be changed once there exists at least one C-scan in the T-scan. These controls are useful to alter the amount of data that exists in the T-scan; setting larger sizes uses proportionally less memory. For example, a standard C-scan of 0.8mm pitch will be re-sampled use  $\frac{1}{4}$  the memory if the T-scan pitch is set to 1.6mm.

### 6.1.2. T-Scan Sub-Menu 2



Figure 68: T-Scan Sub-Menu 2

Control Title	Ctrl. Image	Description
<b>Add</b>		Duplicated from sub-menu 1: see 6.1.1.
<b>Delete</b>		Duplicated from sub-menu 1: see 6.1.1.
<b>Group</b>		Duplicated from sub-menu 1: see 6.1.1.
<b>Ungr.</b>		Duplicated from sub-menu 1: see 6.1.1.
<b>Lock</b>		Duplicated from sub-menu 1: see 6.1.1.
<b>C-S No.</b>		The number of the currently selected C-scan file.
<b>Pos X</b>		The X position of the currently selected C-scan file.
<b>Pos Y</b>		The Y position of the currently selected C-scan file.
<b>Angle</b>		The angle of the currently selected C-scan file.
<b>Use G.</b>		Re-gates the T-scan according to the gates of the currently selected C-scan file.
<b>Z Ord.</b>		Selects z-order C-scan merge algorithm.
<b>L. Peak</b>		Selects largest amplitude peak merge algorithm.
<b>Canv. Col.</b>		Selects the T-scan canvas colour.

The **C-S No.** control allows the user to choose the currently selected C-scan file. A C-scan can also be selected by clicking within its region using the left mouse button. In this case, the **C-S No.** control is updated with the appropriate value.

The **Pos X**, **Pos Y**, and **Angle** controls allow the user to set the position and angle of the currently selected C-scan. These parameters can also be changed directly using the mouse using gestures on the T-scan canvas.

Dragging a C-scan allows its position to be changed. Pressing Ctrl and dragging allows the C-scan to be rotated around the click point.

The **Use G** button allows the gates of a particular C-scan file to be used globally on the T-scan. This feature will be described further in section 6.3.

The **z Ord./L. Peak** radio buttons control the algorithm used when merging overlapping C-scans in the T-scan. The **z Ord.** choice is a simple LIFO (last in, first out) procedure where the last placed C-scan is on top. The **L. Peak** choice is more involved and chooses each A-scan from which to use the gate output as that which resulted in the largest amplitude for that T-scan sample location. When viewing a relative T-scan, the gate on the left hand side of the relative operator (divide or subtract) is used to define which A-scan is used for the relative computation.

### 6.1.3. T-scan Keyboard Shortcuts

In a T-scan session, pressing '0' to '9' on the keyboard selects C-scan x0 to x9 respectively, where the current C-scan number is xa. For example, if the current C-scan number is 27 and the '3' key is pressed, the current C-scan becomes 23. The currently selected C-scan can be moved around the T-scan using the arrow keys and rotated using the arrow keys while pressing the CTRL key. C-scans can be added to the T-scan by pressing the 'a' key and the selected C-scan can be deleted by pressing the 'd' or DELETE key. The T-scan control must have focus for the keyboard shortcuts to take effect.

### 6.1.4. Moving C-scan Positions

The C-scan names shown on the T-scan can now be moved from the middle to either the left or the right-hand side of each C-scan. This behaviour is selected using the Left, Middle, and Right buttons in the Evaluation menu.

## 6.2. Common Behaviour between C-Scan and T-Scan Modes

Some functionality in the T-scan mode of RapidScan is similar or identical to that of functionality in C-scan mode. This section briefly lists such features and any differences in the T-scan compared with the C-scan mode of the program.

### 6.2.1. Extracting A-Scan Data from the T-Scan



Figure 69: A-T-B View Selected

Setting the program view to **A-T-B**, as shown in Figure 69, allows A and B-scan data to be queried and displayed in a similar way to the C-scan mode already described. Figure 70 shows an example of an A and B-scan extracted from the T-scan.

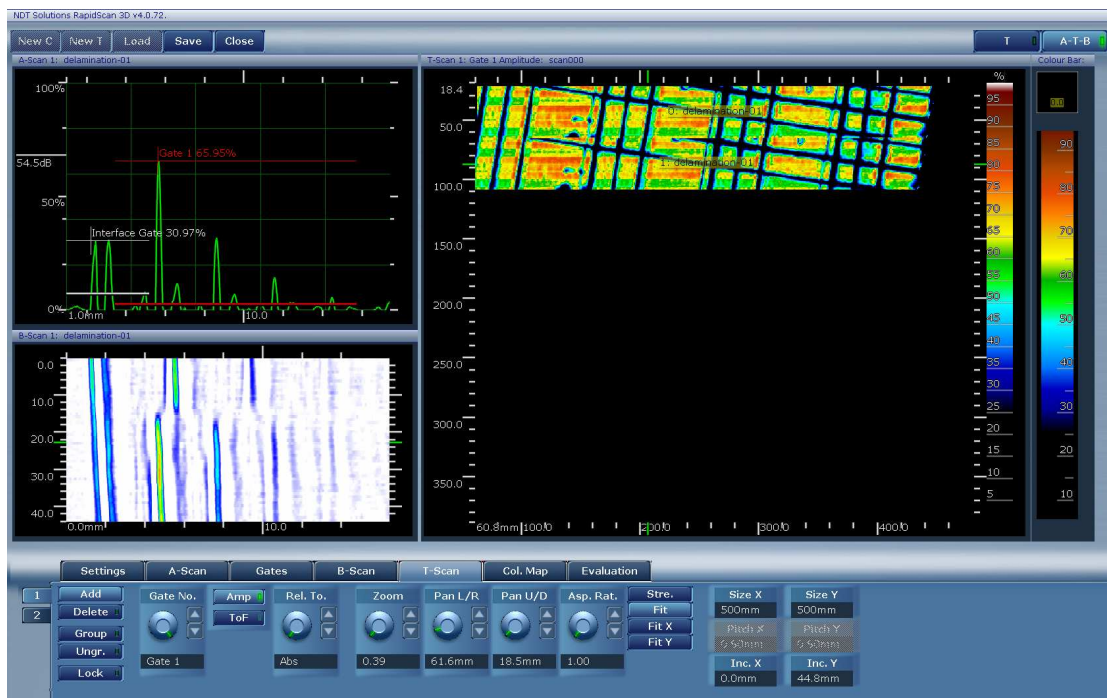


Figure 70: Example of A and B-Scan Extraction from T-Scan

### 6.2.2. Applying the Colour Map



Figure 71: Selecting T-Scan Colour Map

The colour map used for the currently selected gate in the T-scan is selected by activating the T-1 button on the left hand side of Figure 71.

### **6.2.3. Editing the Colour Map**

Colour maps can be edited in the T-scan program mode exactly as for the C-scan mode described in section 5.7.2: Editing the Colour Map.

### **6.2.4. Marking the Defects**

The defects and other features can be created in exactly the same way as for C-scans, as described in section 5.9: Marking the Defects.

Unselecting Verbose in the Evaluation menu turns off blue highlight rectangle.

### **6.2.5. Importing and Exporting Data**

Data can be imported and exported from the T-scan mode in the same way as for the C-scan mode, as described in section 5.10.1: Importing and Exporting Data.

### **6.2.6. Printing Scans and Settings**

Scans and settings can be printed in the same way as the for the C-scan, described in section 5.10: Storing and Printing using the Settings Sub-Menu.

### **6.2.7. Changing the Coordinate Origin**

The (0, 0) origin of the coordinate system in T-scans and C-scans is changed using the space bar while the mouse cursor is at the required location. Rulers, tool-tips and defect objects are measured relative to the origin.

### **6.3. Re-gating the T-Scan**

The T-scan mode of RapidScan features software re-gating of a T-scan. This allows a number of C-scan files to be added into and positioned on the T-scan before applying a different gating configuration to the A-scans to generate new T-scans. This is only possible if the T-scan is constructed from files of extension `abcscan.tif`. Scans with the `cscan.tif` extension do not contain the necessary A-scan data.

Setting the program view to A-T-B, as shown in Figure 69, activates the re-gating functionality in the T-scan mode of RapidScan.

The gate configuration shown in the A-scan window shows the gating and A-scan used to generate the currently selected T-scan sample. The particular gate configuration may be different for different C-scan files added but RapidScan displays the correct gating configuration for the selected C-scan file.

In the A-T-B view mode, the T-scans can be recreated at any time by selecting Regate in the Gates menu. This applies the currently active gate settings to all of the A-scan data already added to derive new T-scans. The gate settings can be changed in the usual manner, either through the Gates menu or by using the mouse on the A-scan display.

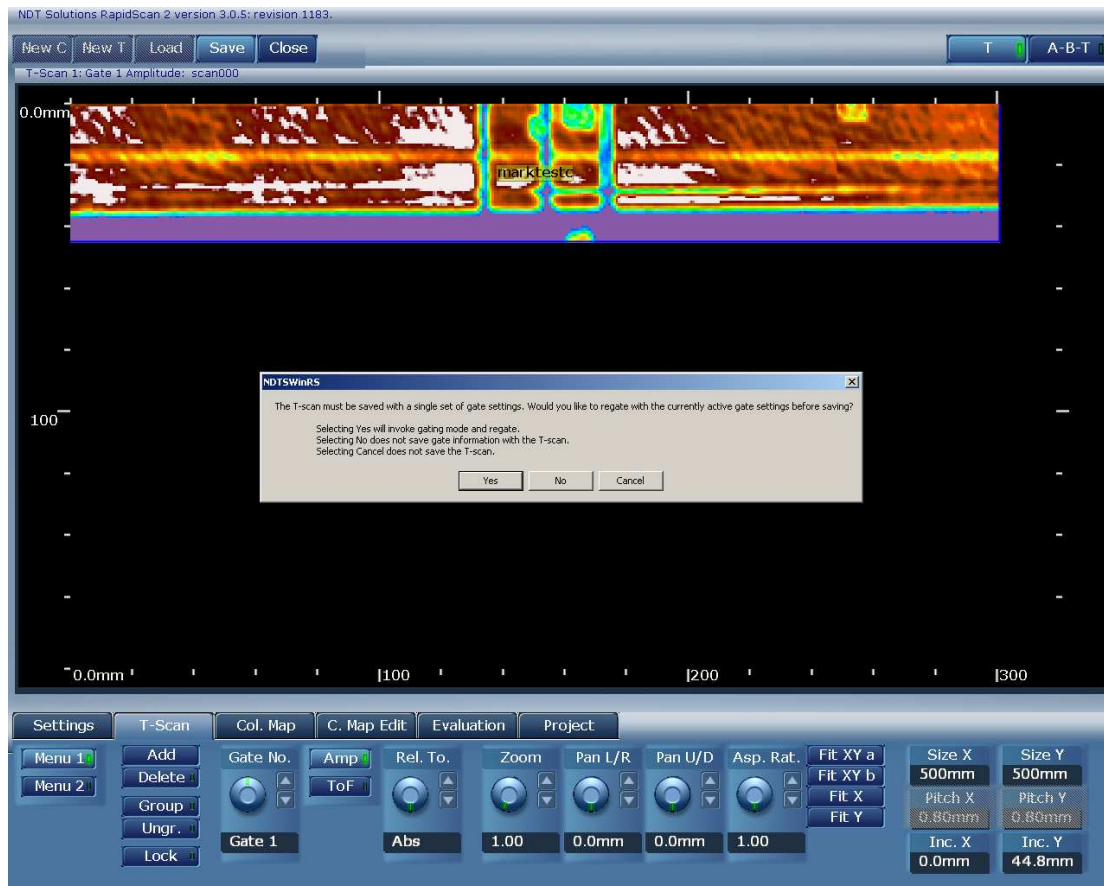
When adding a new `cscan.tif` or `abcscan.tif` file to the T-scans, the gate setup which was originally used may be different to that which is currently active for the T-scans. The generating gates are shown when reviewing A-scans from the new data rather than the active gates of the T-scan. The new data can be re-gated according to the current T-scan gates.

The gates used to originally generate a set of C-scans within a file can be recovered and set as the active T-scan gates by selecting the correct C-scan and then selecting Use Gates in Menu 2 of the T-Scan menu. This re-gates the T-scan according to the corresponding gates.

The ability to contain different gate settings for different C-scan files within a T-scan provides options when the T-scans are about to be saved within a file. Since each T-scan file may only contain a single gate configuration the user is asked whether they would like to re-gate using the currently active gates to ensure consistency before saving. They can, alternatively, just save the T-scan without a gate configuration, leaving the same C-scans that were originally added. See Figure 72 for an image of the user choices dialog.



## 6 Creating a T-Scan using RapidScan



**Figure 72: Gating Choices when Saving a T-Scan**

Note that the existing automatic re-gate function for the C-scan is not activated in the T-scan. Changing a gate position does not automatically re-gate the T-scan; the Regate button in the Gates menu must be used.

## 7. Workflow Tools and Three-Dimensional Scanning and Evaluation

The RapidScan 3D system contains a number of functions which can be used for the scanning and evaluation of 3-dimensional shapes with complex geometry. The system can either be configured with the computer-aided design (CAD) data of the part. Where CAD data is not available, many engineering structures can be approximated using the *stock-shape* feature.

### 7.1. Inspection Repository

RapidScan 3D contains a number of features which are designed to simplify the process for creating and recalling ultrasonic instrument settings for a particular inspection. These components are called the *settings wizards* as they simplify the process of configuring and re-using inspection parameters. These parameters include the ultrasonic instrument settings, probe specification, and 3-dimensional geometry information.

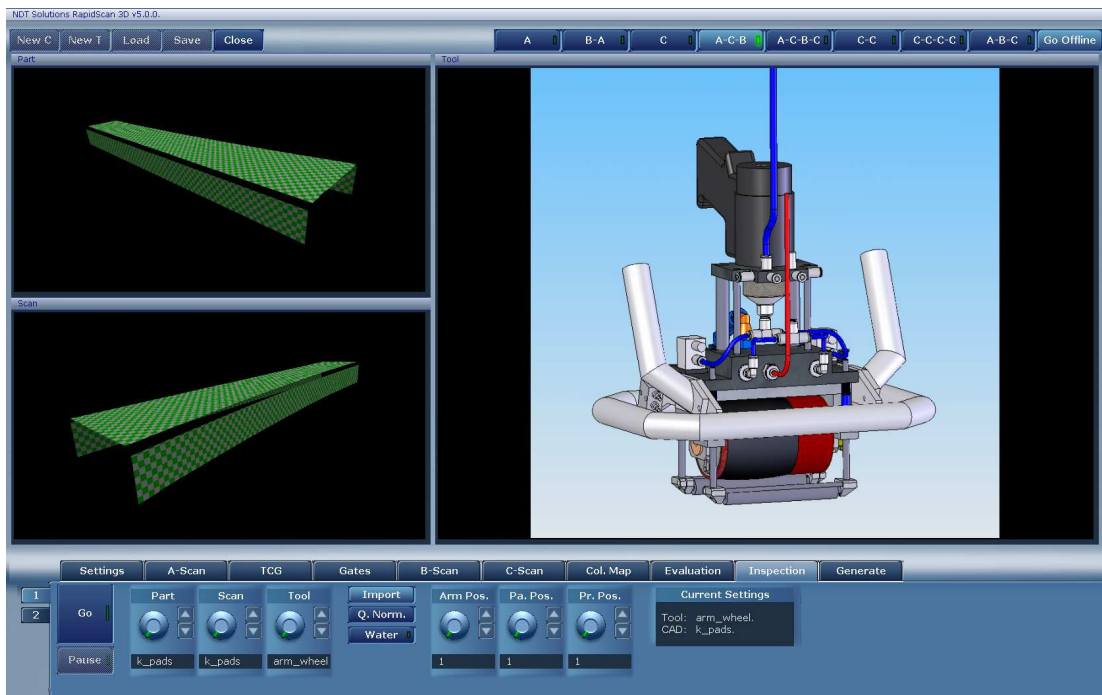


Figure 73: Inspection Selection View

The *inspection* repository provides a record of each of the scans that have been set up using RapidScan. These can be recalled and altered quickly and easily at a later date. The items in the inspection repository can be pre-configured by Sonatest Ltd. and/or may be added to using the inspection generation feature.

The inspection repository is split into two subsets. The first section is for the known parts used for existing inspections and the tools which have been added to an inspection of the particular part; this is called the *part repository*. The second section contains the set of pre-configured tools which are available to be used with the RapidScan system, this is called the *tool*

repository. Items in the tool repository are not initially associated with a particular part but can be added to an inspection if the probe is compatible.

The user-interface onto the inspection repository includes a pictorial representation of each inspection, along with the compatible tools and the scans required to provide full coverage of the particular part, see Figure 73: Inspection Selection View. The particular part, scan and tool selected can be incremented by double-clicking with the left mouse-button on the corresponding image. Similarly, they can be decremented by double-clicking with the right mouse-button. Double-clicking with the centre mouse-buttons resets the selection back to the first.

## 7.2. Inspection Dialog






The inspection dialogs are designed to streamline the process of selecting and configuring inspections.


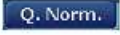





### 7.2.1. Inspection Sub-Menu 1

The first inspection sub-menu contains all of the controls that are needed for an operator to use preconfigured inspection parameters to perform a scan. It includes the functions necessary to recall inspections from the repository as well as start/pause/stop the corresponding scans. In addition, the RapidScan 3D system can be informed of the current arm, part and tool position (if applicable.)



Figure 74: The Inspection Sub-Menu 1

Control Title	Ctrl. Image	Description
Go		Start capturing a C-scan. See section 5.6, <b>Performing a C-Scan</b> , page 55.
Pause		Pause the C-scan capture. See section 5.6, <b>Performing a C-Scan</b> , page 55.
Part		Select the target part for the inspection from the repository of known objects.
Scan		Select the target scan for the inspection from the chosen part.
Tool		Select the tool or probe to be used for the inspection.

<b>Import</b>		Import the settings for the currently selected part/scan/tool combination.
<b>Q. Norm</b>		Perform quick probe normalisation. See section <b>5.1.3.1, Quick Array Normalisation</b> , page 36.
<b>Water</b>		Activates the water couplant delivery system for the inspection.
<b>Arm Pos.</b>		Select the arm position to be used for the current scan (if applies).
<b>Part Pos.</b>		Select the part position to be used for the current scan (if applies).
<b>Probe Pos.</b>		Select the probe position to be used for the current scan (if applies).
<b>Current Settings</b>		Displays the name of the tool whose settings are currently loaded. Displays the name of the currently loaded CAD data (for RS3D only)

### 7.2.2. Parts, Scans and Tools

The RapidScan system is compatible with a number of off-the-shelf and custom ultrasonic probes. These may include a transducer array, or a number of single element transducers, or even a single transducer. Examples of tools which contain an ultrasonic array are the NDTs FaroArm wheel-probe and sliding-tools. Examples of probes which contain a number of single element transducers are the NDTs radii tools. Each probe is designed for a general class of surface geometry, with the most common being flat or slightly curved and radii of between 5mm and 20mm. The settings wizard takes care of identifying which class of probe are suitable for a particular type of geometry.

The distinction between part and scan is made as there may be more than one type of scan required to complete the inspection of a particular part. For instance, a carbon-fibre aerospace sample may include flat areas as well as radii connecting those areas. The flat areas are most suitably scanned with the wheel-probe whereas the radii portions would be well suited to inspection using the radii tools. The settings wizard can be configured to include these different areas and corresponding tools within the same overall inspection.

Each part, scan region and tool combination is associated with a different set of ultrasonic instrument settings. For example, the settings for a wheel-probe are different from those for a radii probe, and these may vary between parts due to, for example, different materials or thicknesses.

### 7.2.3. Operator Workflow for Selecting and Starting a Scan

This section assumes that the operator has a number of different parts to inspect, each of which has been configured to appear in the Inspection Wizard.

1. Select **Inspection** dialog.
2. Choose the part to scan using either the **Part** control or by double clicking the part image displayed until the correct part is found.
3. Select the next scan within the part using the **scan** control or by double-clicking the scan image. If there is a single scan within the inspection, the correct scan will be already displayed.
4. The name of the compatible tool for this scan will be displayed in the **Tool** control as well as its image in the inspection view. There may be more than one tool possibility available; however, if only one tool is available for the scan, it will be automatically selected.
5. Select the Import button to configure the RapidScan system for the inspection.
6. Use the displayed tool to scan the marked region of the part after hitting the Go button.
7. Use the Stop button when the scan is complete. Save the scan data using the Save button.
8. Go to step three, while inspection scans remain for the current part.
9. Go to step two, while parts remain to be scanned.












### 7.2.4. Inspection Sub-Menu 2

The second inspection sub-menu provides the functions to fine-tune a particular inspection within the repository.



Figure 75: Inspection Sub-Menu 2

Control Title	Ctrl. Image	Description
Active		Toggles between preset INI file inspection tool configuration and basic RS2 tool configuration mode.
Orient.		Toggles the orientation of the tool.
Q. Norm		Perform a quick probe normalisation. See section 5.1.3.1, <b>Quick Array Normalisation</b> , page 36.
Q.N. Delay		The delay applied between selecting the <b>Q. Norm</b> button and the corresponding data being collected. See section 5.1.3.1, <b>Quick Array Normalisation</b> , page 36.

<b>Q.N. Gate</b>		The gate to be used during quick normalisation. See section <b>5.1.3.1, Quick Array Normalisation</b> , page 36.
<b>M.A. Gate</b>		Maximum amplitude gate; the gate whose amplitude is used to select between multiple A-scans collected for the same physical position.
<b>Part</b>		Select the target part for the inspection from the library of known objects.
<b>Scan</b>		Select the target scan for the inspection from the chosen part.
<b>Tool</b>		Select the tool or probe to be used for the inspection.
<b>Save Settings</b>		Save the current ultrasonic settings for the currently selected part/scan/tool combination.
<b>Calibrate</b>		Calibrate the position and orientation of the currently selected part using the FaroArm.
<b>Test Part</b>		Test the current part position/orientation calibration using the FaroArm.
<b>Delete Part</b>		Remove the currently selected part from the repository.
<b>All Tools</b>		Provides a list of tools which are compatible with the current scan/part combination.
<b>Add Tool</b>		Adds the tool selected in <b>All Tools</b> to the currently selected part.

### 7.2.5. Special Gates

The RapidScan system uses two special gates which are used before and during a scan. These are standard RapidScan gates but have extra meaning associated with them.

The **Q.N. Gate** choice is used with the quick normalise **Q.Norm.** function to remove any small changes in gain across the transducers due to variations in manufacture. This feature would be used with a homogenous test block, free of any defects, and would be performed before the scan. The echo used for normalisation can be the front or back face but it must not be saturated and the gain requirements for its successful measurement must not be so high as to make the echo noisy. In addition, the coupling between the probe and test block must be made as good as possible. This process is described in more detail in section **5.1.3.1, Quick Array Normalisation**, page 36.



The second special gate is used during scanning, the maximum amplitude gate chosen with the **M.A.Gate** control. This provides the RapidScan system with the information required to choose between multiple A-scans for the same physical position. This situation occurs, for example, when the wheel-probe is reversed and an area is re-scanned due to poor coupling or other problems. The RapidScan system will use the new A-scan if its measurement corresponding to the **M.A.Gate** is of higher amplitude than the existing A-scan collected at that physical position. The **M.A.Gate** is often chosen to cover the backwall echo and so the algorithm will choose the A-scan with the best coupling between probe and sample.

### 7.2.6. Workflow for Updating Ultrasonic Settings for a Tool

The ultrasonic settings for a part/scan/tool combination can be altered once the inspection has been configured.

1. Select part/scan/tool combination using the Part, Scan and Tool controls.
2. Select Import.
3. Alter settings in usual way.
4. Select **Save Set.** button to overwrite the current settings for the part/scan/tool combination.

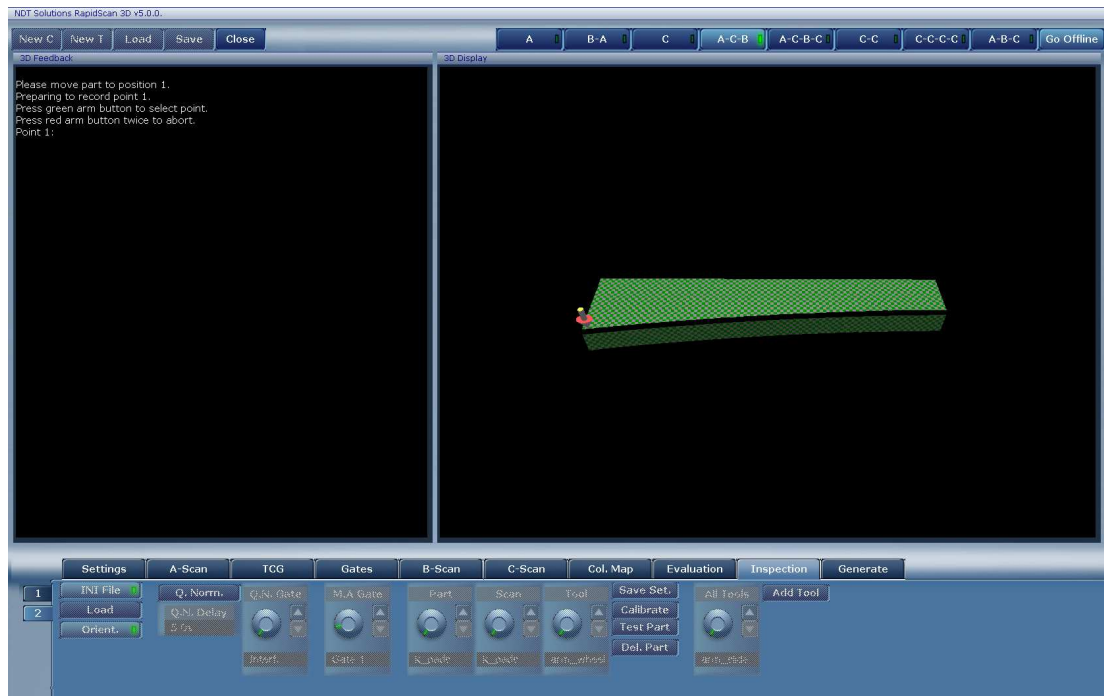
### 7.2.7. Workflow for Calibrating the Position of a Part

The position and orientation of a 3-dimensional part must be calibrated before a scan can be made using the RapidScan 3D system. This involves selecting three pre-configured points using the FaroArm, this is called the *three-point calibration*. The part and the arm should be securely positioned during the calibration and inspection. If the position of the part or the base of the arm is changed, the calibration must be repeated. (Please note: the calibration of an existing part is only available for some specific parts)

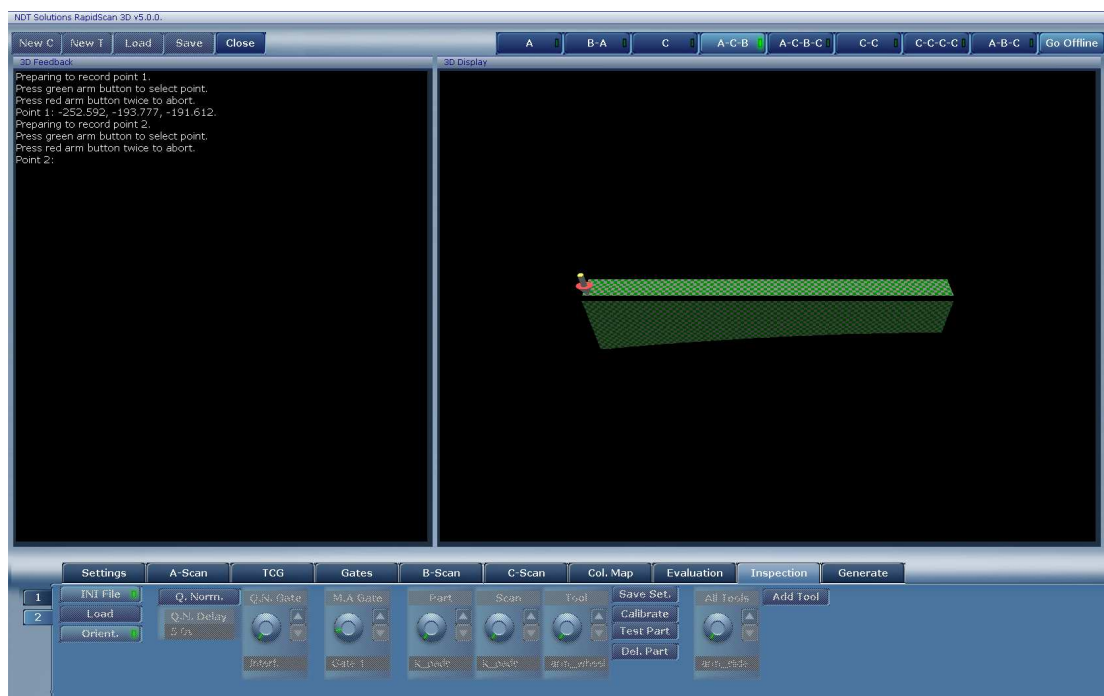
1. Select the part to be calibrated using the **Part** control.
2. Select the **ball\_3mm** tool and ensure the 3mm ball probe is attached to the FaroArm.
3. Select the **Import** button to load initialise the system with the correct geometry data.
4. Select **Calibrate**.
5. Follow the on-screen prompts to select each calibration point using the green button of the FaroArm. See Figure 76, Figure 77 and Figure 78.
6. While calibration points remain, go to step five. If a calibration point is selected in the wrong place, press the red button on the FaroArm and go to step four.
7. Check that the distances for each point are small, no more than around 5mm. If these are large, go to step three and try to be more accurate.

Once the part has been calibrated successfully with a tool (usually the ball-probe), it can be used with the other probes available for that part.

## 7 Workflow Tools and Three-Dimensional Scanning and Evaluation



**Figure 76: Selecting Calibration Point One of 3-Dimensional CAD Data**



**Figure 77: Selecting Calibration Point Two of 3-Dimensional CAD Data**



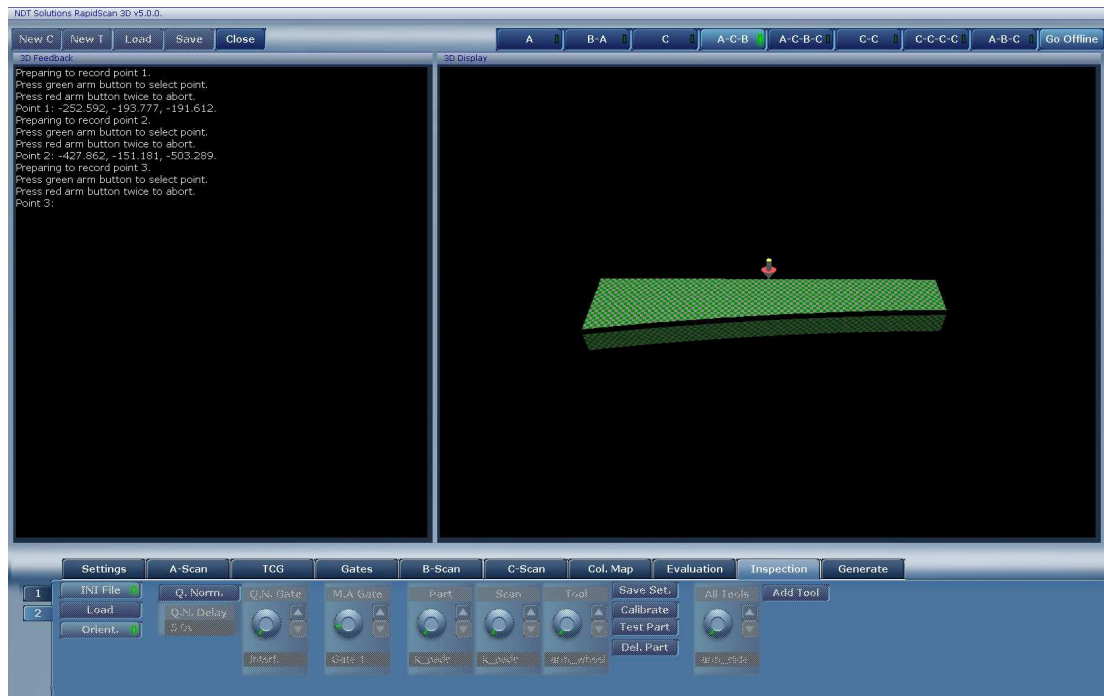


Figure 78: Selecting Calibration Point Three of 3-Dimensional CAD Data

### 7.2.8. Workflow for Testing the Part Calibration

Once a three-point calibration has been performed, the **Test Part** mode can be used to verify that RapidScan 3D has successfully found the correct orientation of the object

1. Select the appropriate part and tool combination using the **Part** and **Tool** controls.
2. Select the **Import** button.
3. Select **Test Part**.
4. Move the probe over difference regions of the part and ensure the distance and angle measurements displayed are small when the probe is on the surface of the part and is correctly aligned, see Figure 79. In addition, the RS3D system will show the position of the probe relative to the part using an arrow; this should closely match the reality.

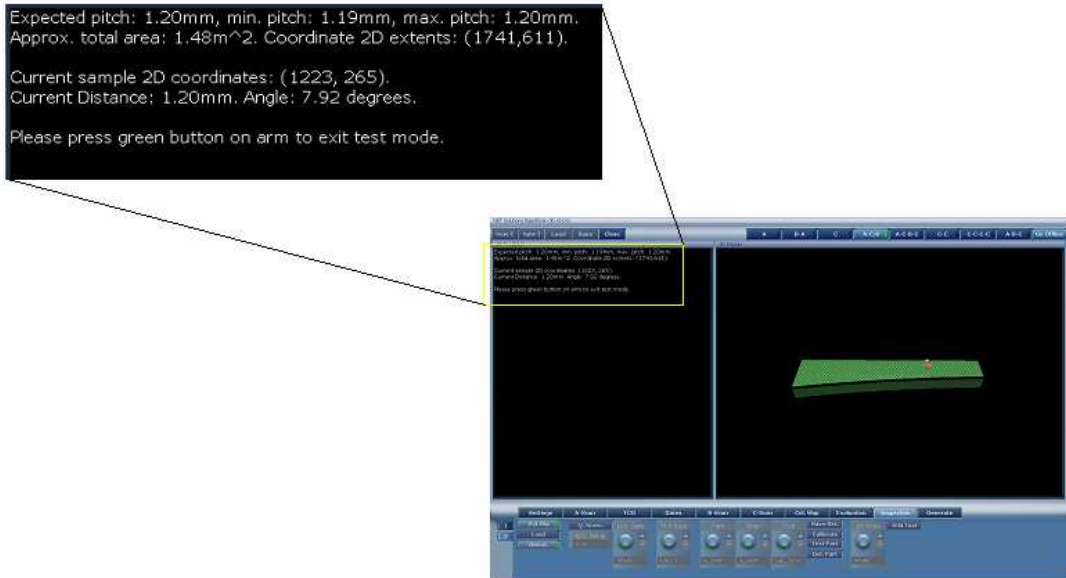


Figure 79: Test Part Mode for CAD Data

### 7.2.9. Workflow for Deleting an Inspection from the Repository

An inspection can be permanently deleted from the repository if it is no longer useful.

1. Select the target part using the Part control.
2. Select **Delete Part** control.

The part will no longer appear within the inspection repository.

### 7.2.10. Workflow for Adding a Tool to an Inspection

A tool can be added to an existing inspection if it is compatible with the particular scan.

1. Select the target part and scan using the Part and Scan controls
2. Select the new tool with the list of compatible tools in the **All Tools** control.
3. Select **Add Tool** control.

This tool will now appear within the inspection wizard and be available for use on the scans for the region of the corresponding part. The settings used are the current

### 7.3. Inspection Generation

The second *settings wizard* feature within the RapidScan software is concerned with the generation of new inspections using the items within positional device, shape, and tool repositories respectively. Once generated, the inspection is added to the inspection repository ready to be re-used at a later date.

The inspection generation wizard also contains a pictorial view of the currently selected positional device, stock-shape type and tool. The current selection can be altered in a similar way to the inspection selection wizard by double-clicking the mouse on the corresponding image.







### 7.4. Generate Dialog


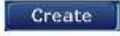






The inspection generation dialog contains the controls necessary for the generation of new inspections. The positional device, shape and tool can be selected for the inspection to be created, as well as its name, scan resolution and whether it is to be permanently added to the inspection repository.

#### 7.4.1. Generate Menu



Figure 80: Generate Menu

Control Title	Ctrl. Image	Description
Go		Start capturing a C-scan. See section 5.6, <b>Performing a C-Scan</b> , page 55.
Pause		Pause the C-scan capture. See section 5.6, <b>Performing a C-Scan</b> , page 55.
Device		Selects the target device for the inspection. For example, 1D encoder-based or FaroArm.
Shape		Selects the target shape for the inspection.
Tools		Selects the target tool for the inspection. For example, wheel-probe or radii probe.
Name		The name for the inspection to be created. This name will appear in the part repository.

<b>Pitch</b>		The pitch of the scan for the inspection.
<b>Create</b>		Creates the inspection for the currently selected device/shape/tool combination.
<b>Temp.</b>		Toggles whether the inspection is temporary or should be stored in the repository for future use.
<b>Calibrate</b>		Calibrate the position and orientation of the currently selected part using the FaroArm.
<b>Test Part</b>		Test the current part position/orientation calibration using the FaroArm.
<b>Test Arm</b>		Test basic functionality of the FaroArm.
<b>Faro Dialog</b>		Display the FaroArm configuration dialog.
<b>Calculate Psi</b>		Calculate the Psi zero-angle of the FaroArm.

### 7.4.2. Workflow for Testing FaroArm

The basic functionality of the FaroArm can be tested using the **Test Arm** mode.

1. Select the **Test Arm** button.
2. Move the end of the FaroArm around and check that the position and direction values change smoothly, see Figure 81.
3. Press green arm button to exit mode.

Pos.: (776.54, -107.31, -99.89). Dir.: (0.02, -0.99, -0.14).  
Please press green button on arm to exit test mode.

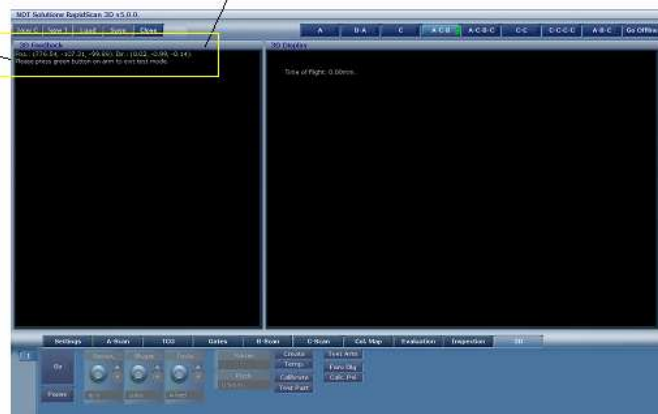


Figure 81: Test Arm Mode

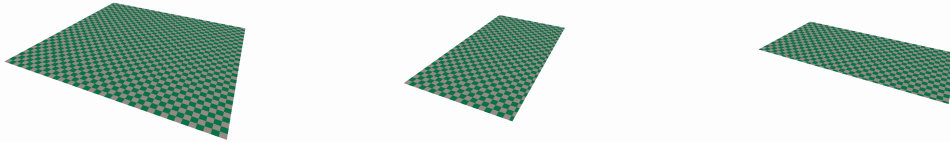
### 7.4.3. Workflow for Calculating FaroArm Zero-Angle

Due to manufacturing reasons, the angle of rotation of the end of the FaroArm must be calibrated to ensure the RapidScan 3D system is supplied with accurate measurements for the orientation of the transducer array within the ultrasonic probe. This can be achieved using the zero-degree calibration function.

1. Attach the white cube-shaped zero-degree calibration block to the FaroArm.
2. Select Calc. Psi. button.
3. Press the white block onto a flat surface with the handle grip pointing upwards.
4. Press the green arm button to collect the zero-degree angle.
5. The angle reported should be close to zero degrees but may be around 180 degrees in certain positions of the block. If the angle is not close to zero, go to step three and rotate the block position.

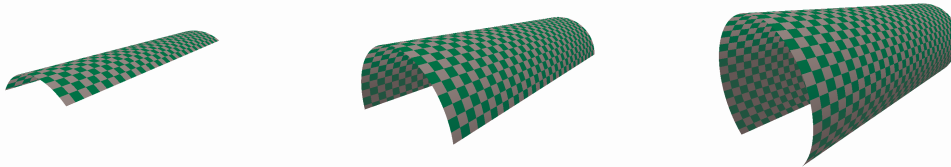
### 7.5. Introduction to Stock-Objects Shape Generation

RapidScan 3D provides a mechanism for the generation of 3-dimensional geometry data which can be used for scanning of flat or curved objects which match or are similar to certain simple shapes. This feature is called *stock-object generation*. The currently supported stock objects are planes, portions of cylinders, complete cylinders and portions of spheres.



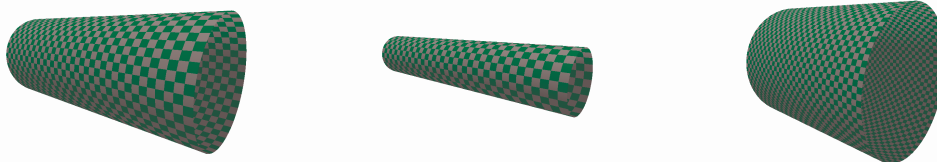
**Figure 82: Examples of Instances of Plane Stock-Object**

The plane stock-object type can be used to scan common flat or approximately flat shapes.



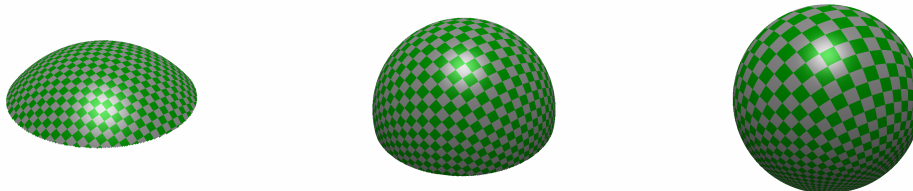
**Figure 83: Examples of Instances of Cylinder-Section Stock-Object**

RapidScan 3D contains separate stock-object types for arcs of cylinders and complete cylinders.



**Figure 84: Examples of Instances of Full-Cylinder Stock-Object**

The cylinder-based stock-object type can be used to scan pipes, pressure vessels or similarly-shaped samples.



**Figure 85: Examples of Instances of Spherical-Arc Stock-Object**

The sphere-based stock-object type can be used to scan, for example, radomes in aerospace contexts or the ends of pressure vessels for industrial applications.

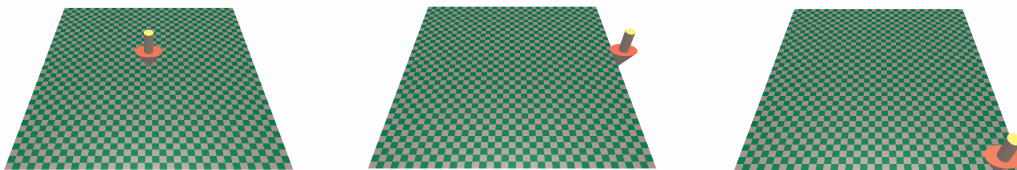
When presented with a particular sample to scan, the operator chooses the stock-shape type which most closely matches the general target geometry. A number of points on the part are then selected using the FaroArm and the RapidScan 3D system uses these to generate an instance of the stock shape type which matches the part to be scanned. The object may not be perfectly flat, cylindrical or spherical but the system will execute a mathematically optimal “best-fit” algorithm to find an appropriate approximation.

### **7.6. Stock-Object Calibration**

The RapidScan system supports a number of different types of stock-object classes which require different calibration procedures. However, the different calibration points that are required for each have been chosen in an intuitive and unified way. The first point always corresponds to the centre of the scanning area; the second point is always to the right of the first and defines the size of the horizontal axis of the 2-dimensional C-scan visualisation as well as its physical direction. The third point defines the size of the vertical axis of the 2-dimensional C-scan visualisation if it is not already implicitly defined by point two. Points four and above, if required, do not directly define the size of the scanning area but serve to provide enough information for the “best-fit” algorithm to provide an accurate solution.

An instance of a stock-object can be generated at a variety of target scan pitches, which is the length of the sides of each 3-dimensional square corresponding to each C-scan sample. This can be increased to trade-off scanning area against resolution, with larger area scans being possible with a larger pitch. Once a stock-object instance has been generated, however, the pitch is fixed for that inspection; if an alternative pitch is required then a new stock-object instance must be calibrated. Changing the target pitch does not alter the calibration procedure.

#### **7.6.1. Plane Stock-Shape**

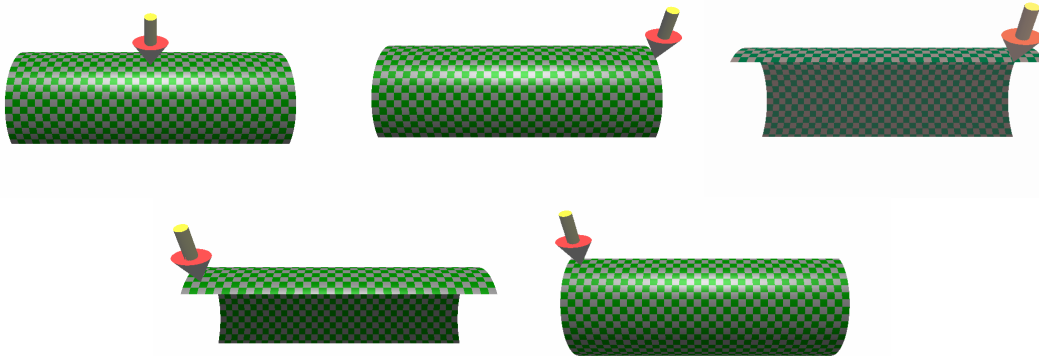


**Figure 86: Points 1 to 3 of plane stock-object calibration (left to right).**

Calibration of the plane stock-object type requires the operator to select three points using the FaroArm. The first point corresponds to the physical position of the centre of the desired scanning-area. The second point defines the horizontal size as twice the distance between the first and second points. In addition, the first and second points define which physical direction corresponds to left to right on the visualisation of the scan within RapidScan. The third calibration point defines the vertical size of the scan as being twice the distance between it and the horizontal line defined by points one and two.



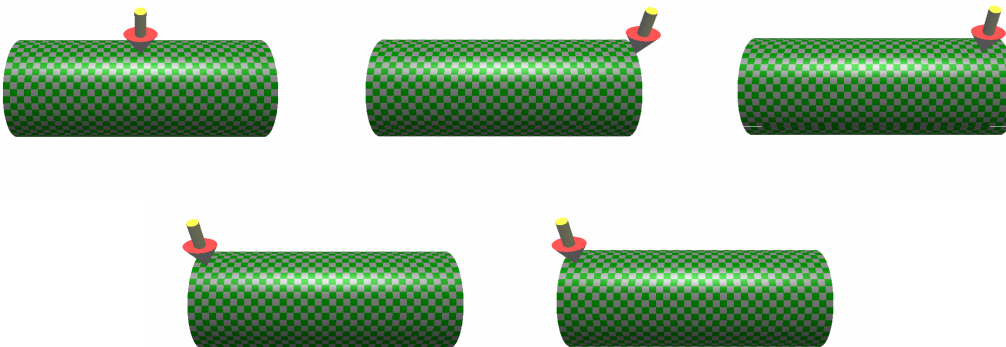
### 7.6.2. Cylinder-Section Stock-Shape



**Figure 87: Points 1 to 5 of cylinder-section calibration (left to right, top to bottom)**

Calibration of the cylinder-section stock-object type requires the operator to select five points using the FaroArm. The first point corresponds to the centre of the resulting scanning area, in terms of both horizontal length and resulting angle used to create the arc. The second point defines the horizontal length in the sense that it is twice the distance from point one to point two along the axis of the cylinder. The third point defines the angle used for the arc of the cylinder; it is twice the angle from point three to point two. Finally, points four and five are not used to define the length or angle for the cylinder arc; these are just used to provide enough information a unique solution for the algorithm to find the best-fitting cylinder to the points. However, points four and five should be chosen in a similar position to that shown in the images above.

### 7.6.3. Full Cylinder Stock-Shape



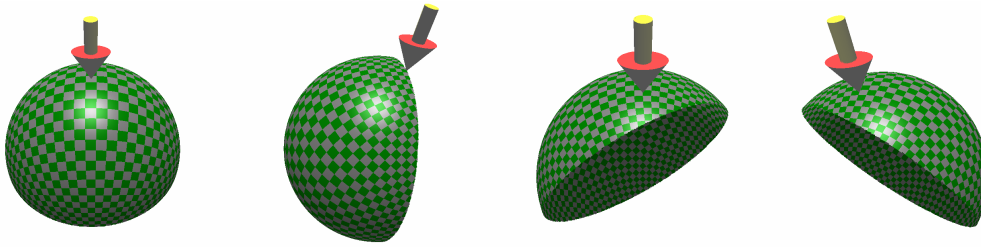
**Figure 88: Points 1 to 5 of full cylinder calibration (left to right, top to bottom)**

Calibration of the full cylindrical stock-object type requires the operator to select five points using the FaroArm. The first point of corresponds to the centre of the resulting scanning area, in terms of both horizontal length and resulting angle used to create the arc. The second point defines the horizontal length in the sense that it is twice the distance from point one to point two along the axis of the cylinder. The third point defines the angle used for the arc of the cylinder; it is twice the angle from point three to point two. Finally, point three to five are used to provide enough information a unique solution



for the algorithm to find the best-fitting cylinder to the points. However, these points should be chosen in a similar position to those in the images above.

### 7.6.4. Spherical-Arc Stock-Shape



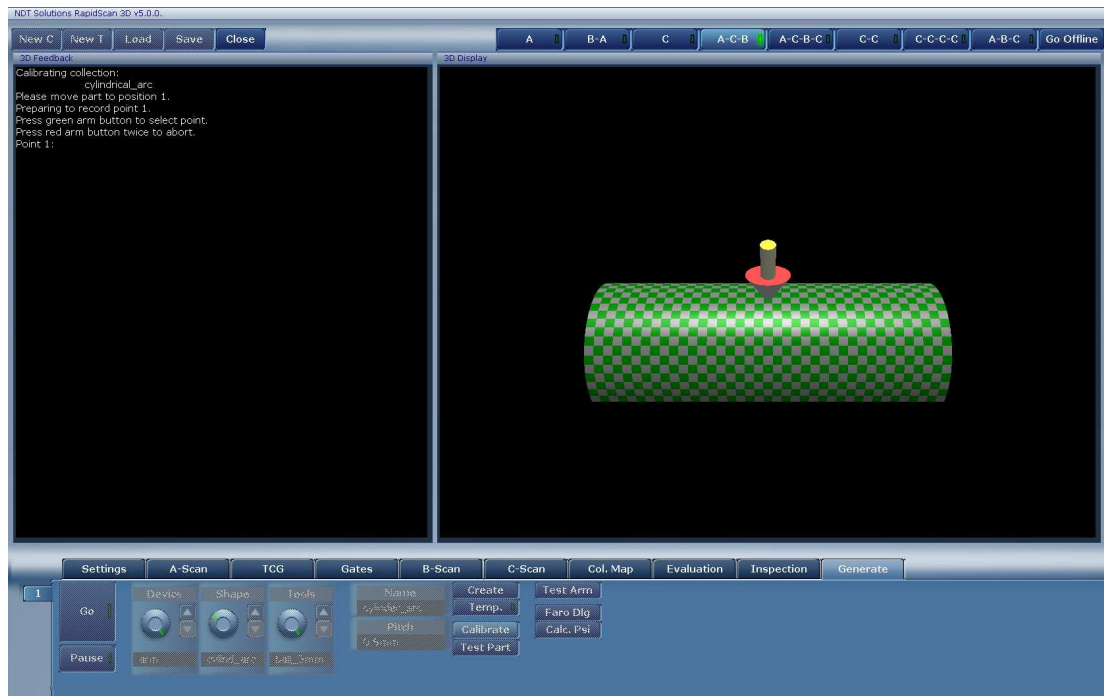
**Figure 89: Points 1 to 4 of spherical-arc calibration (left to right,)**

Calibration of the spherical-arc stock-object type requires the operator to select four points using the FaroArm. The first point of the calibration corresponds to the centre of the region to be scanned. The second point defines the angle of the arc as twice the angle between the first and second point. Points three and four do not define the parameters of the sphere directly and serve only to provide sufficient information for the best-fit algorithm

### 7.6.5. Workflow for Generating a New Inspection

A new inspection can be created by configuring the controls in **Generate** sub-menu 1.

1. Select positional device using the Device control. This will almost always be encoder for RapidScan 3D inspections.
2. Select the shape of the region to be scanned using the **shape** control. This might be radii or flat with RS2.
3. Select the compatible tool from the **Tool1** control.
4. Provide a name for the inspection with the **Name** control.
5. Select whether the inspection should permanently appear within the inspection repository using the **Temp.** button.
6. Select **create** button to start the creation of the inspection using the current ultrasonic settings.
7. Follow the onscreen information to select each calibration point with the FaroArm, ensure that the chosen Tool is connected to the arm. Use the green arm button to select a point or the red to exit. See Figure 90.
8. While calibration points remain, go to step seven.
9. Use the **Test Part** function to check the quality of approximation to the part using the calibration points chosen in step seven.

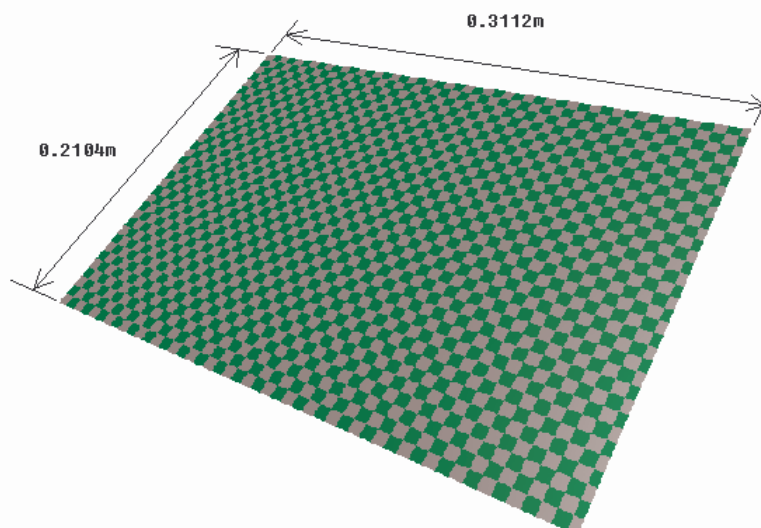


**Figure 90: Calibrating Point 1 of Cylinder-Section Stock-Shape**

### 7.6.6. Stock-Object Information

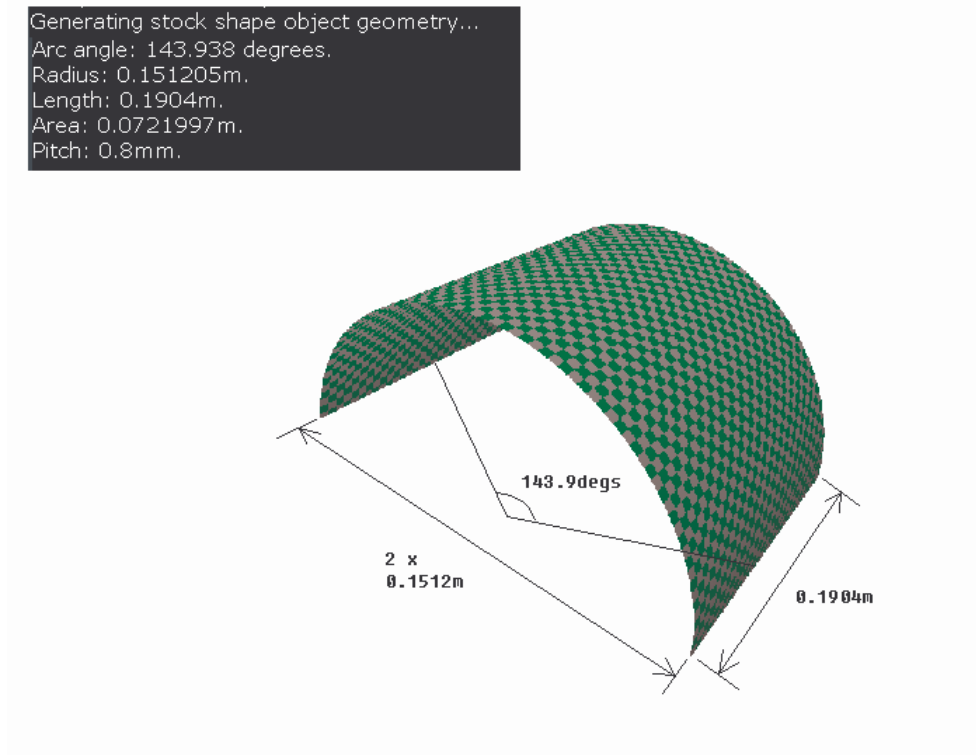
Once an instance of a stock-object has been generated using the calibration points supplied using the FaroArm, RapidScan 3D provides information on the geometric data which is used for the subsequent inspection.

```
Generating stock shape object geometry...  
Size: (0.3112, 0.2104)m.  
Area: 0.0654765m^2.  
Pitch: 0.8mm.
```



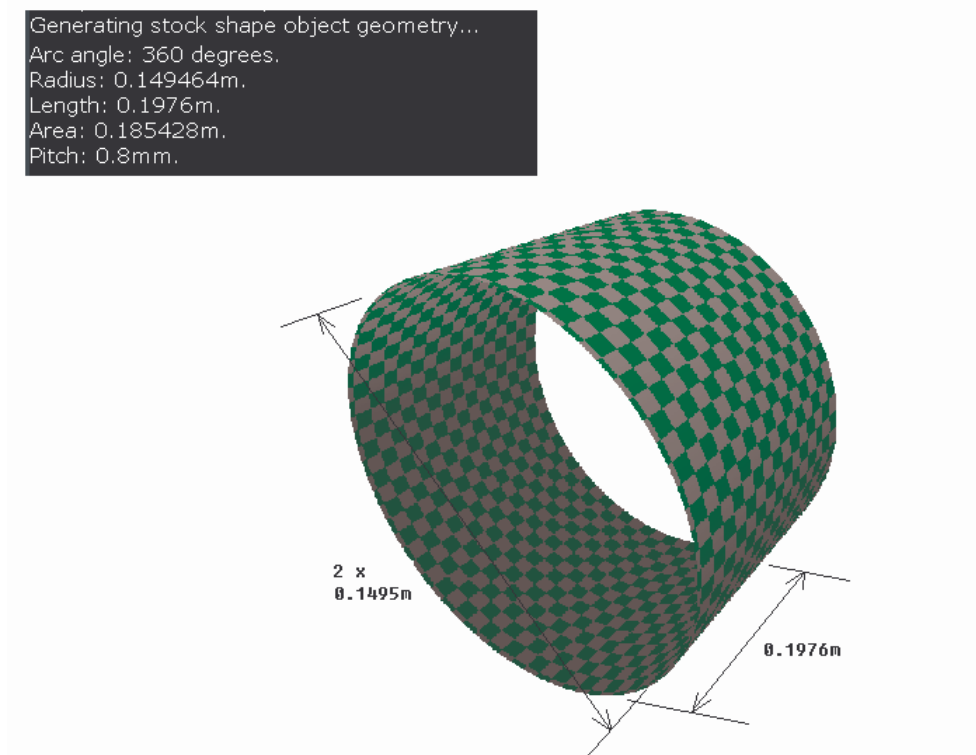
**Figure 91: Information on Plane Stock-Object Class**

The information for the plane stock shape includes the horizontal and vertical size, as well the area, see Figure 91.



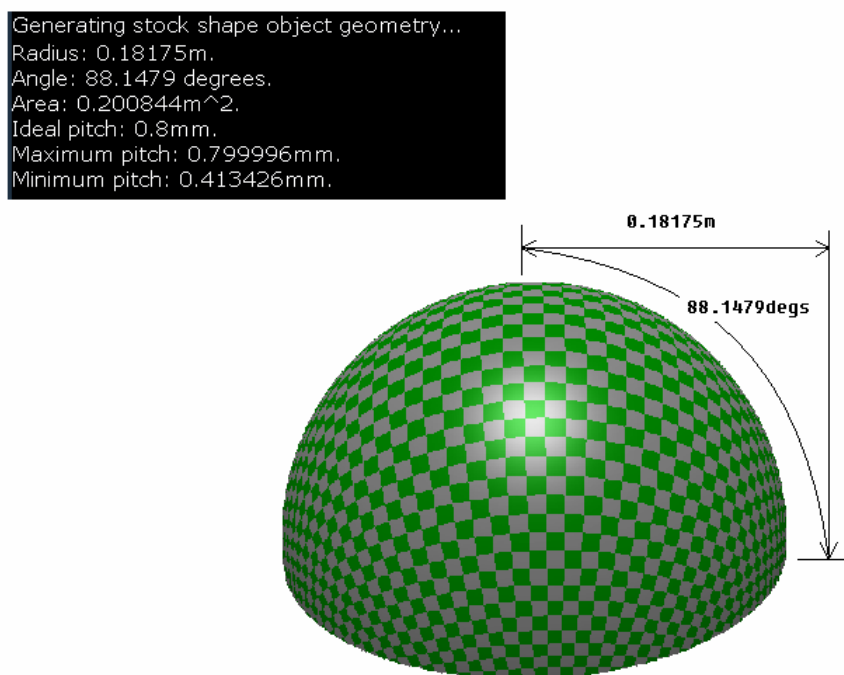
**Figure 92: Information on Cylinder-Section Stock-Object Class**

The information displayed for the cylinder-section stock-shape includes the arc angle, radius, length and area, see Figure 91.



**Figure 93: Information on Full Cylinder Stock-Object Class**

The information displayed for the cylinder-section stock-shape includes the arc angle, radius, length and area, see Figure 93.



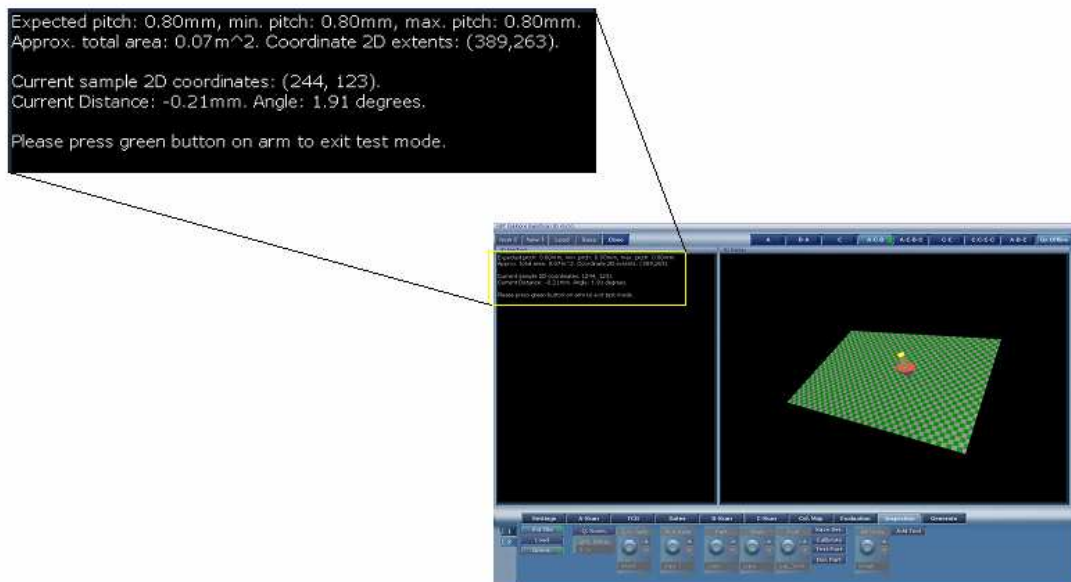
**Figure 94: Information on Spherical-Arc Stock-Object Class**

The information displayed for the spherical-arc stock-shape includes the radius, arc angle, and area, see Figure 94. In addition, since it is impossible to flatten a portion of a sphere without introducing some distortion, the bounds on the resulting scan pitches are also displayed. The other stock-shape types are flattened without any distortion.

### 7.6.7. Testing Stock-Shape Part Calibration

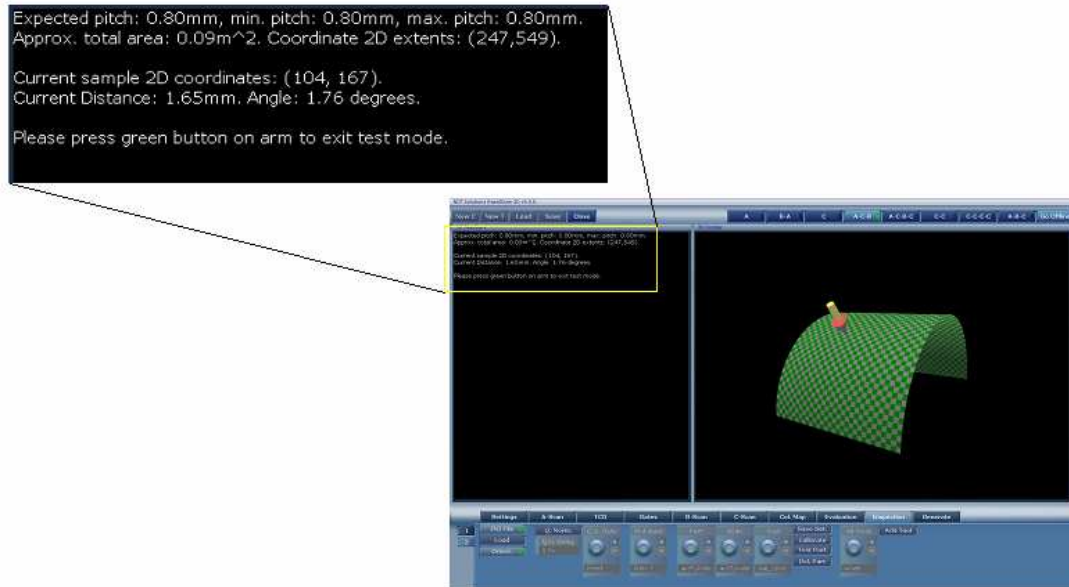
The Test Part feature can be used with a stock-shape calibration to check that the object has been adequately approximated by the chosen mathematical shape and calibration points. A 3-dimensional view of the generated geometrical shape is supplied which can be compared to the actual required shape and scanning area.

The RapidScan 3D system provides a real-time 3-dimensional display of the position of the probe relative to the scanning area. In addition, the distance and angle of the current probe position relative to the shape. The probe can be positioned at various places over the part and should remain on the surface in the 3-dimensional view. The reported angle and distance should remain small if defective area measurements on the resulting scan are to be accurate. Angles of less than 10 degrees and distances of less than 15mm are acceptable for good results.



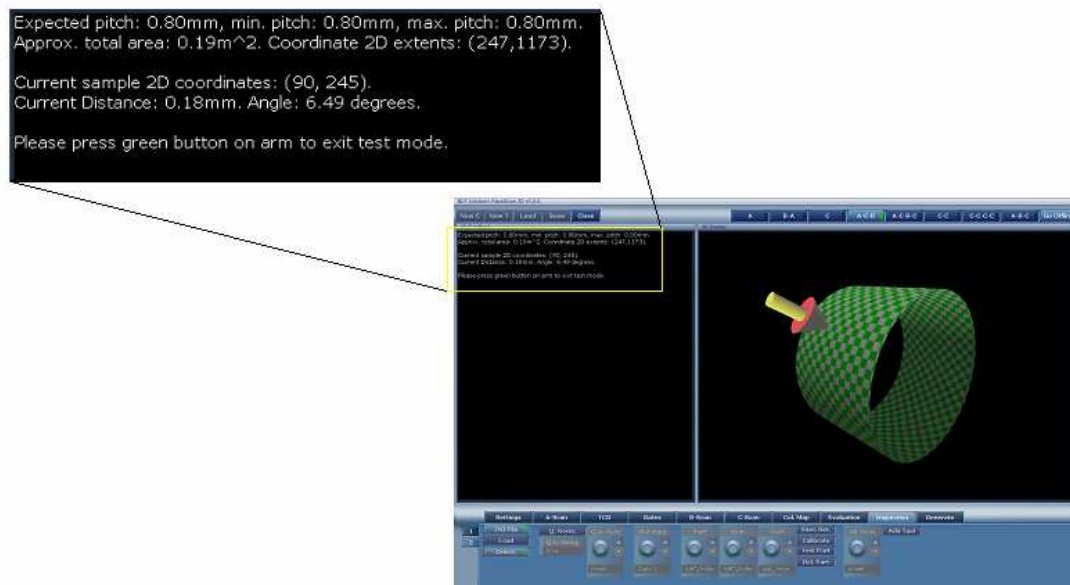
**Figure 95: Test Part Mode with Plane Stock-Shape**

Figure 95 shows a typical display for the Test Part mode with the calibration of a plane stock-shape. See that the distance and angle measurements are small, demonstrating that the generated geometry is a good match to the physical part.



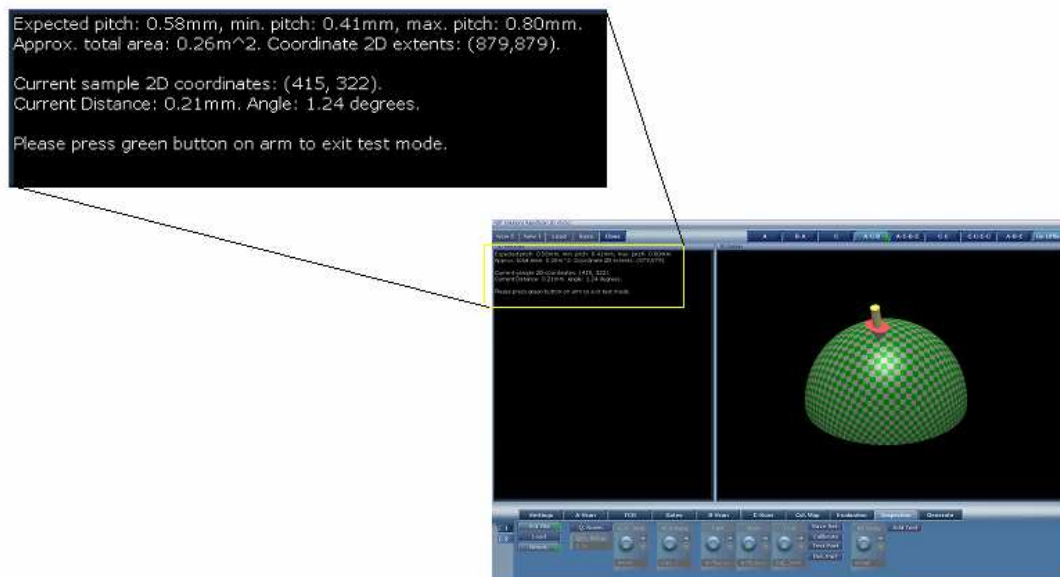
**Figure 96: Test Part Mode with Cylinder-Section Stock-Shape**

Figure 96 shows a typical display for the Test Part mode with the calibration of a cylinder-section stock-shape.



**Figure 97: Test Part Mode with Full-Cylinder Stock-Shape.**

Figure 97 shows a typical display for the Test Part mode with the calibration of a full-cylinder stock-shape.



**Figure 98: Test Part Mode with Spherical-Arc Stock-Shape**

Figure 98 shows a typical display for the Test Part mode with the calibration of a spherical-arc stock-shape.

## **7.7. Manipulating 3-Dimensional Visualisation**

RapidScan 3D includes a user-interface to map mouse-gestures into movements of the 3D visualisation of a part. These include *translation*, *rotation*, *zoom*, *inspect* and *reset*. This section provides information on these basic operations, which are independent of any ultrasonic-specific evaluation.

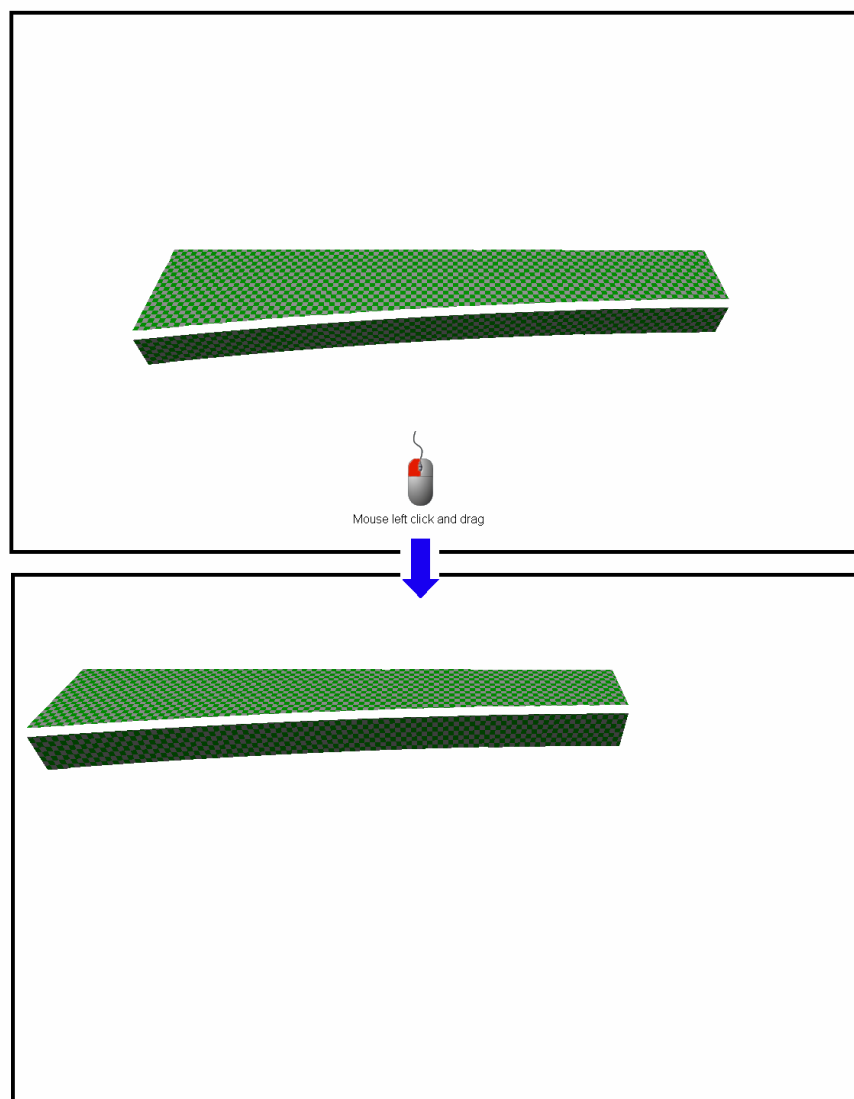
### **7.7.1. Basic Mouse-Gesture Reference**

Mouse-Gesture	Result
Left-drag	<i>Translate</i> part following the mouse position
Middle-drag	<i>Rotate</i> part following mouse position
Wheel-rotate	<i>Zoom</i> in/out around mouse position
Left double-click on part	Zoom in to <i>inspect</i> corresponding area of part
Right double-click	<i>Reset</i> 3D view

### **7.7.2. Translating 3-Dimensional View**

The 3-dimensional object can be moved within the display by click-and-dragging the left mouse-button. The object will follow the mouse-position, regardless of its current position and orientation.





**Figure 99: Translation of 3D object**

Figure 99 shows an example of the translation of a 3D object.

### **7.7.3. Rotating 3-Dimensional View**

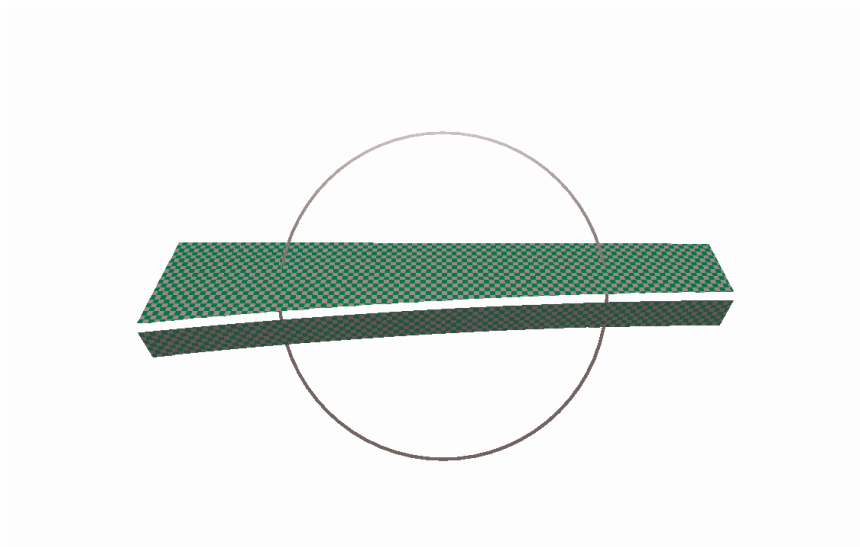
The mouse user-interface for the rotation of a 3D object is slightly more complicated than translation as it requires the conversion of a 2-dimensional movement into a 3-dimensional movement.

Clicking and holding the middle mouse-button will cause a circle to appear, centred on the 3D object, see Figure 100. The circle is part of a virtual sphere positioned on the object which is rotated in different ways using the mouse, which corresponds directly to rotations of the 3D object. The rotation behaviour that results when the mouse is dragged depends on the position of the mouse cursor relative to this rotation sphere.

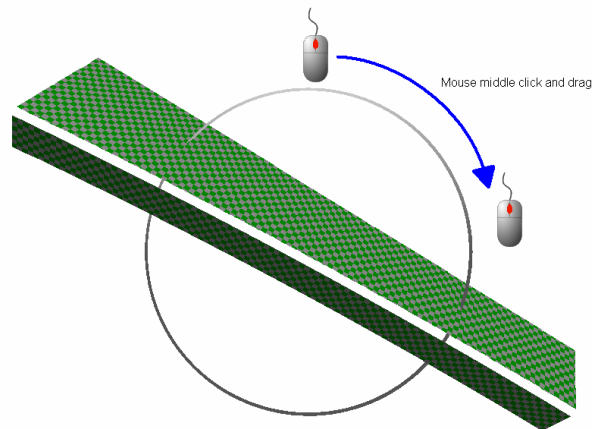
If the mouse cursor is outside of the rotation sphere, holding and dragging using the middle-button will rotate the object around the view direction axis.

The angle that the mouse has moved relative to the centre of the rotation sphere maps directly to the angle that the object is rotated, see Figure 101.

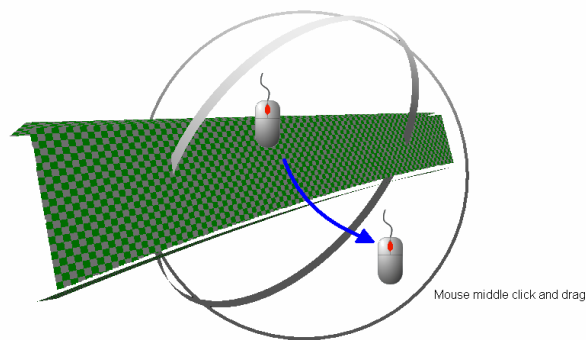
If the mouse is dragged inside the rotation sphere then the rotation axis depends on the start and end position of the drag. The first mouse click defines a point on the rotation sphere and the current drag position defines a second. The rotation that is applied to the 3D object is that which rotates the sphere so that the first point is moved to the second position. The circle representing the rotation sphere is rotated in the same way to provide an indication of the change of rotation as a result of the mouse-gesture, see Figure 102.



**Figure 100: Start of rotation of 3D object**



**Figure 101: Rotation of 3D object with mouse outside of rotation sphere**



**Figure 102: Rotation of 3D object with mouse inside of rotation sphere**

### 7.7.4. Zooming 3-Dimensional View

The 3D visualisation of the object can be zoomed in and out around a point by rotating the mouse-wheel. The position that the zoom is relative to corresponds to the current mouse cursor position. This allows easy closer inspection of areas of interest of the part by positioning the mouse-cursor on the corresponding area and rotating the mouse-wheel; the point of the part under the mouse-cursor does not change position.

In the top part of Figure 103, the mouse cursor position is marked by a blue circle. Rotating the mouse-wheel leads to the bottom image where the corresponding point on the part is still in the same position of the view window.

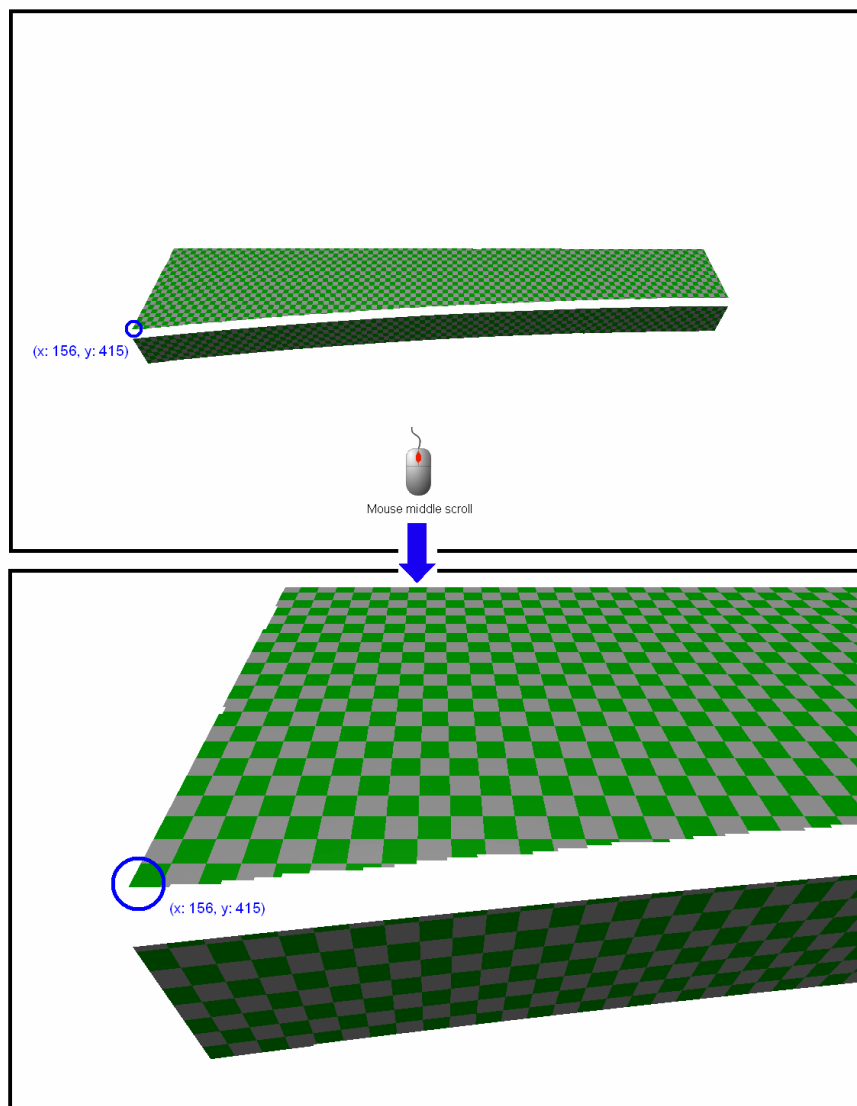


Figure 103: Zoom around point on 3D object

### 7.7.5. Quick Inspection in 3-Dimensional View

In addition to the basic translation, rotation and zoom functions, there are a number of extra features which provide combinations of these movements simultaneously to provide more complicated view changes automatically.

The *inspect* function allows a region of the part to be inspected quickly. Double-clicking with the left mouse-button on a point of the part will change the 3D view so that this point is moved to the centre of the window, the rotation of the part is set to match the view of the part when scanned and the zoom is set to give a close-up view of the corresponding area, see Figure 104.

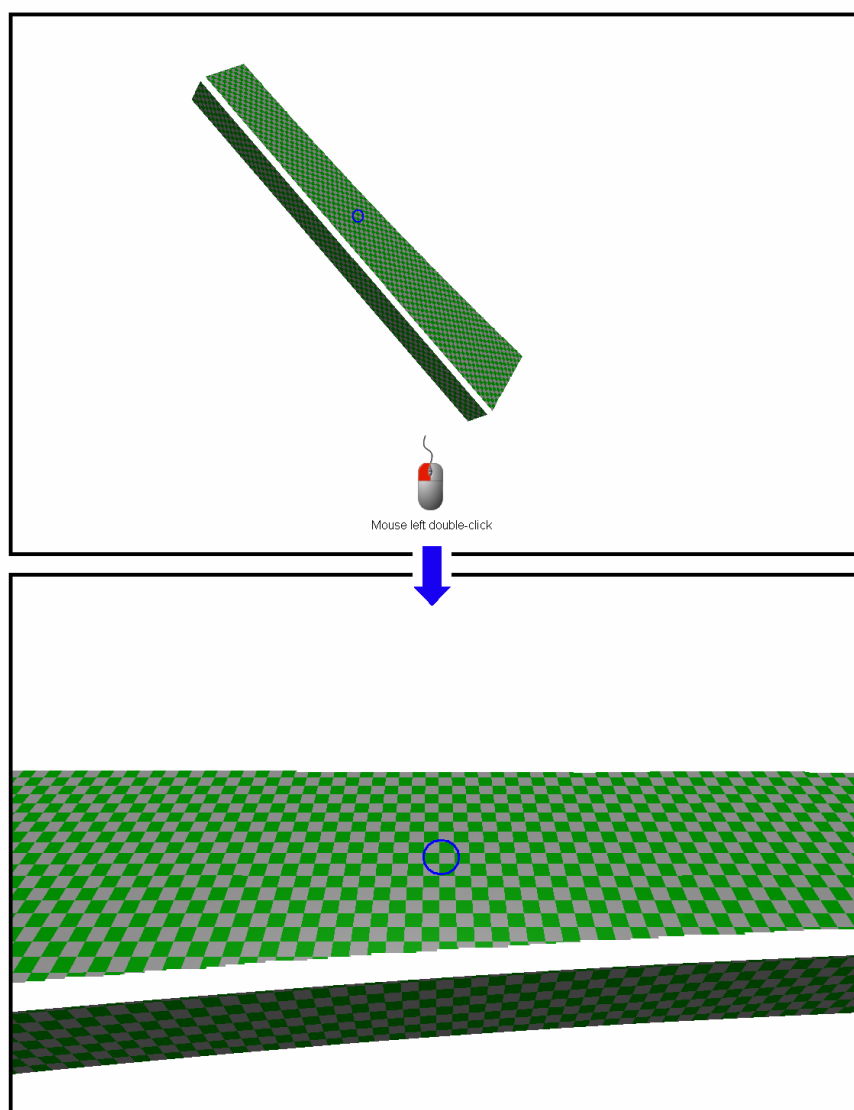


Figure 104: Inspect region of 3D Object

### 7.7.6. Quick Reset of 3-Dimensional View

The 3D view can be quickly reset by double-clicking the right-mouse button anywhere on the window. This moves the part so that its centre is positioned at the middle of the view and the whole part can be seen; in addition, its rotation is reset to provide the view of the part seen when scanned, see Figure 105.

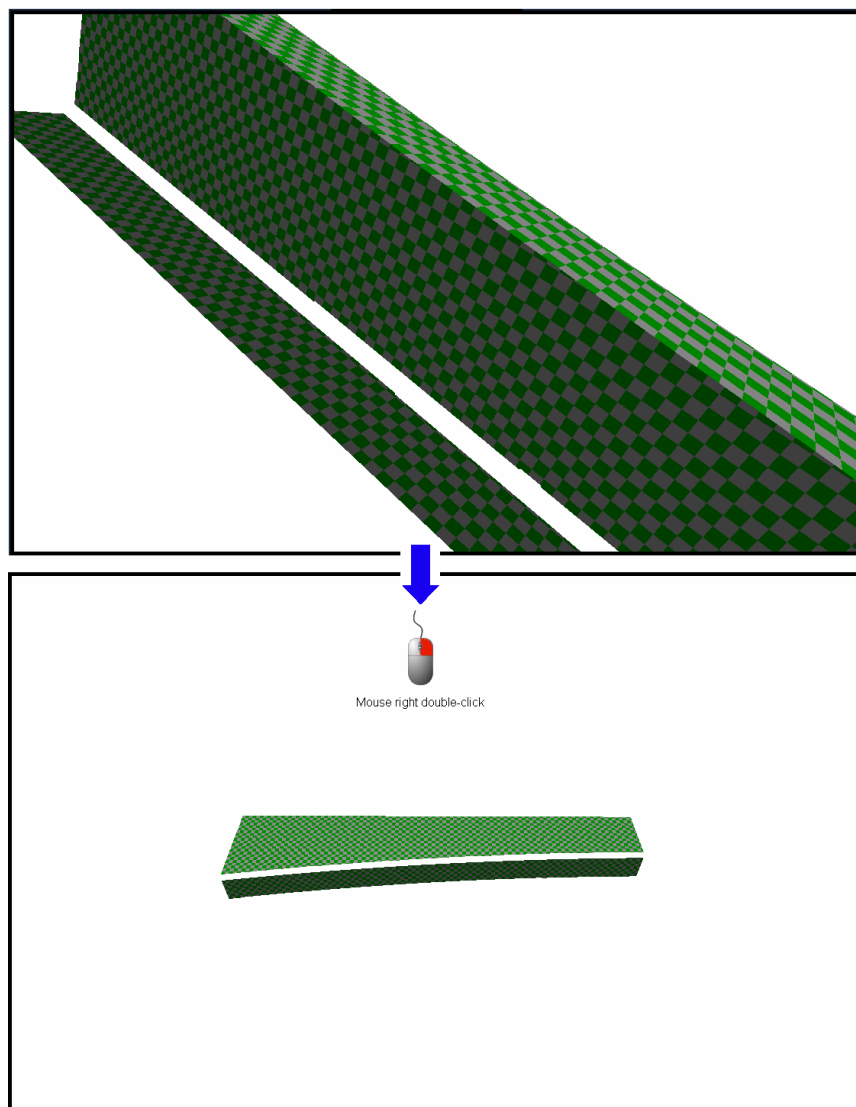


Figure 105: Reset view of 3D object

### 7.8. Scanning in 3-Dimensions

The RapidScan 3D system allows the relationship between the C-scan and geometry data to be visualised in real-time in 3-dimensions during scanning. In addition, the system also supports the standard 2-dimensional rendering provided by RapidScan. Each C-scan window can be chosen to display a three or two dimensional view independently by selecting the corresponding view and selecting 2D or 3D within the C-scan dialog.

The 3-dimensional view that is displayed during scanning is designed to match the actual view of the operator. This provides an intuitive representation during scanning.

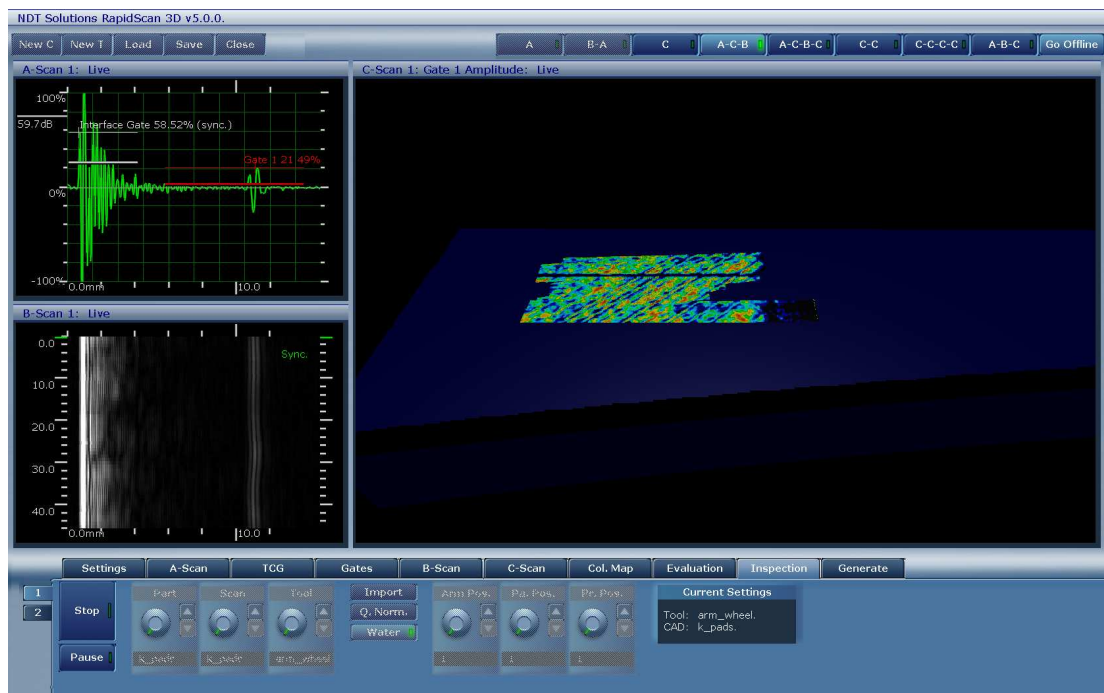
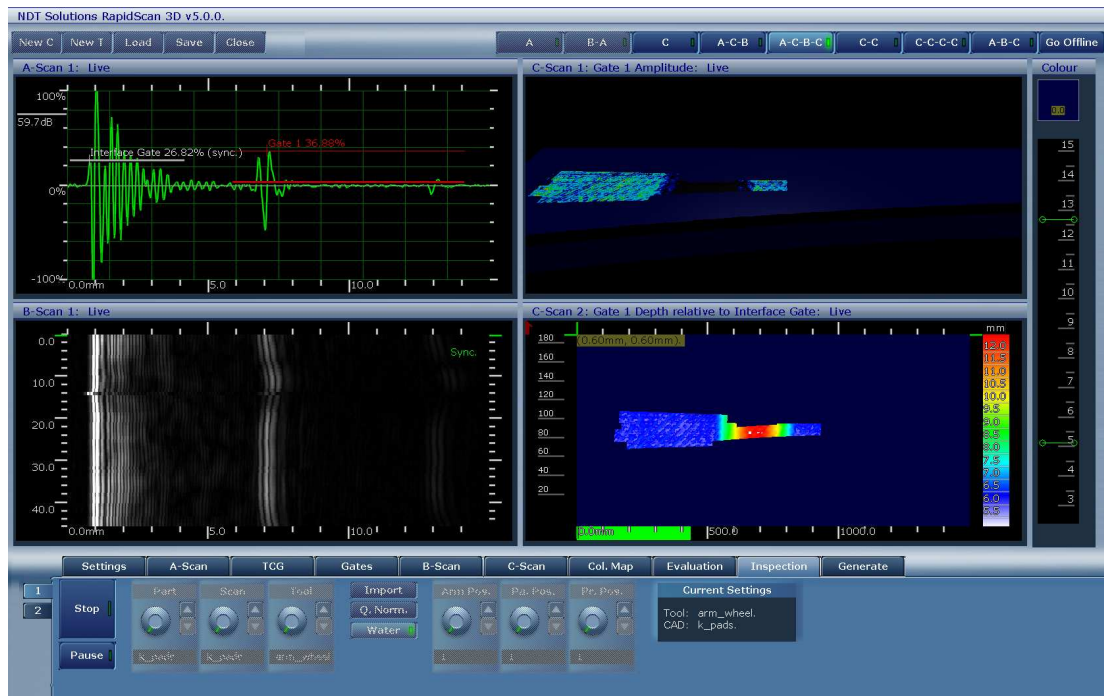


Figure 106: During Scanning with RapidScan 3D - ACB View

Figure 106 and Figure 107 show the RapidScan 3D in mid-scan in two different view configurations.



**Figure 107: During Scanning with RapidScan 3D - ACBC View**

Once scanning is completed, the 3-dimensional visualisation can be manipulated and a number of the evaluation tools from RapidScan have been generalised to this higher-dimensional case.



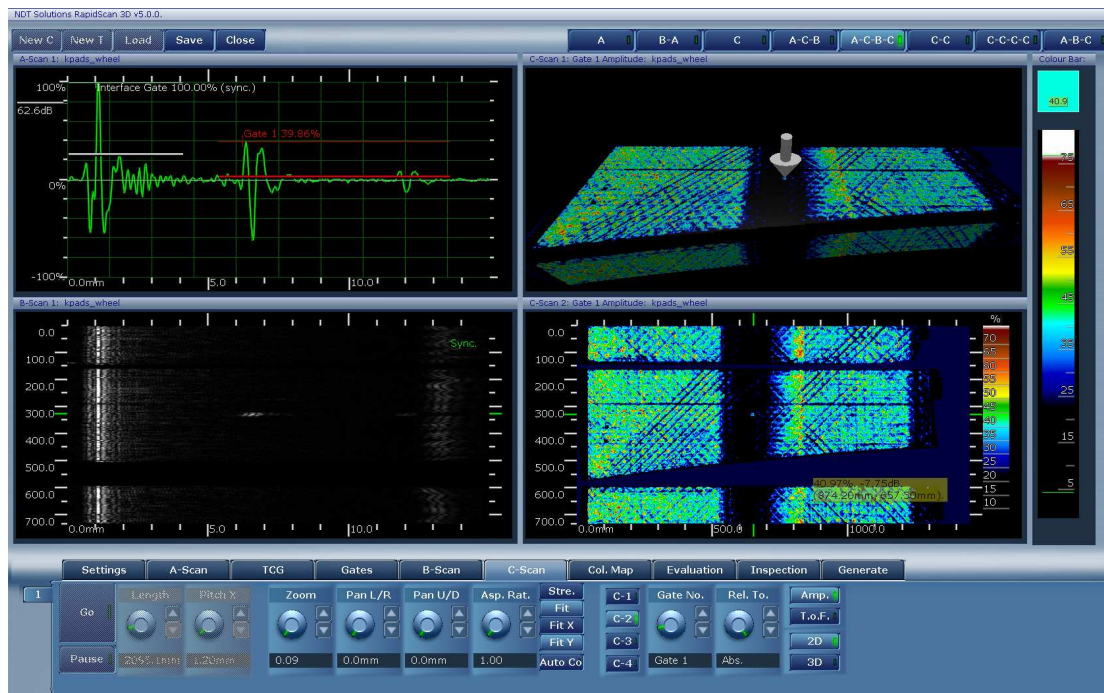
## 7.9. Evaluating Ultrasonic Data in 3-Dimensions

RapidScan 3D includes a number of functions which can be used to evaluate ultrasonic data in 3-dimensions using a number of positioning devices, such as the mouse and the FaroArm. This provides a quick and intuitive view of the relationship between the scan data and the physical part which is more difficult to provide using only a 2-dimensional view.

### 7.9.1. Using the Mouse

RapidScan 3D provides a number of features for the evaluation of ultrasonic data in 3-dimensions using the mouse. The mouse-gestures are designed to be similar to those used for evaluation of standard 2D C-scans.

Dragging the right mouse-button on the 3D visualisation will pick A and B-scans in the same way as for 2-dimensions. The currently selected A-scan is marked by a grey arrow. Figure 108 provides an example of this function where the A-scan is chosen from a defective area of the part.

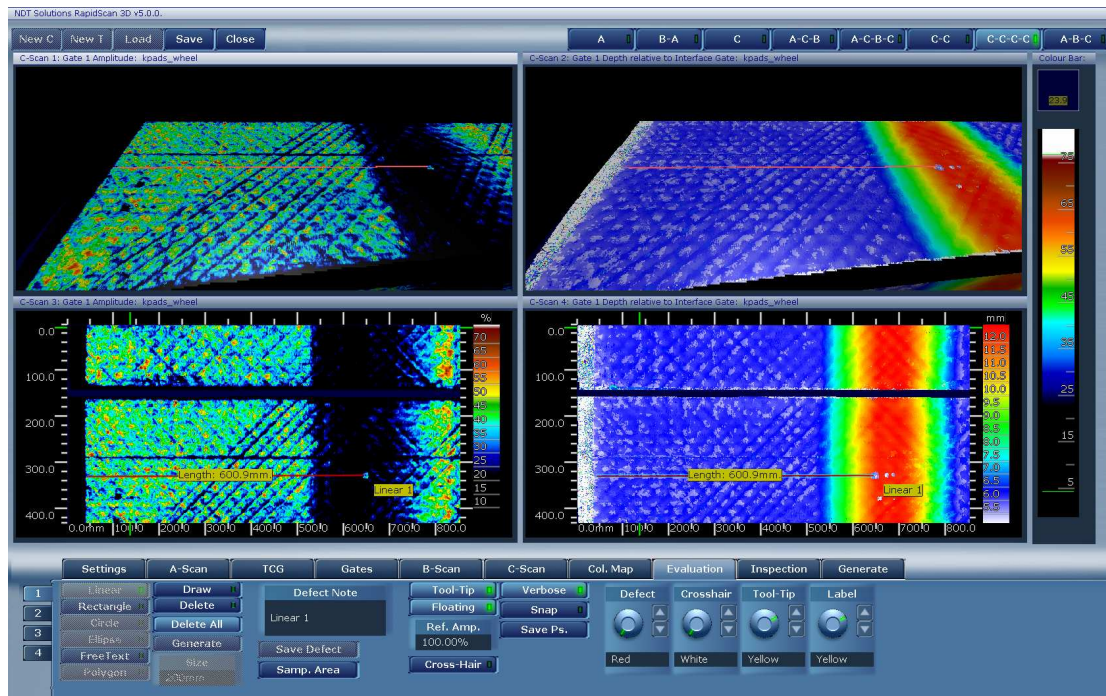


**Figure 108: Evaluating A and B-scans in 3-Dimensions using the Mouse**

The position of the grey arrow on the 3D view is also updated when A-scans are picked using the right mouse-button on the 2D C-scan in the usual way.

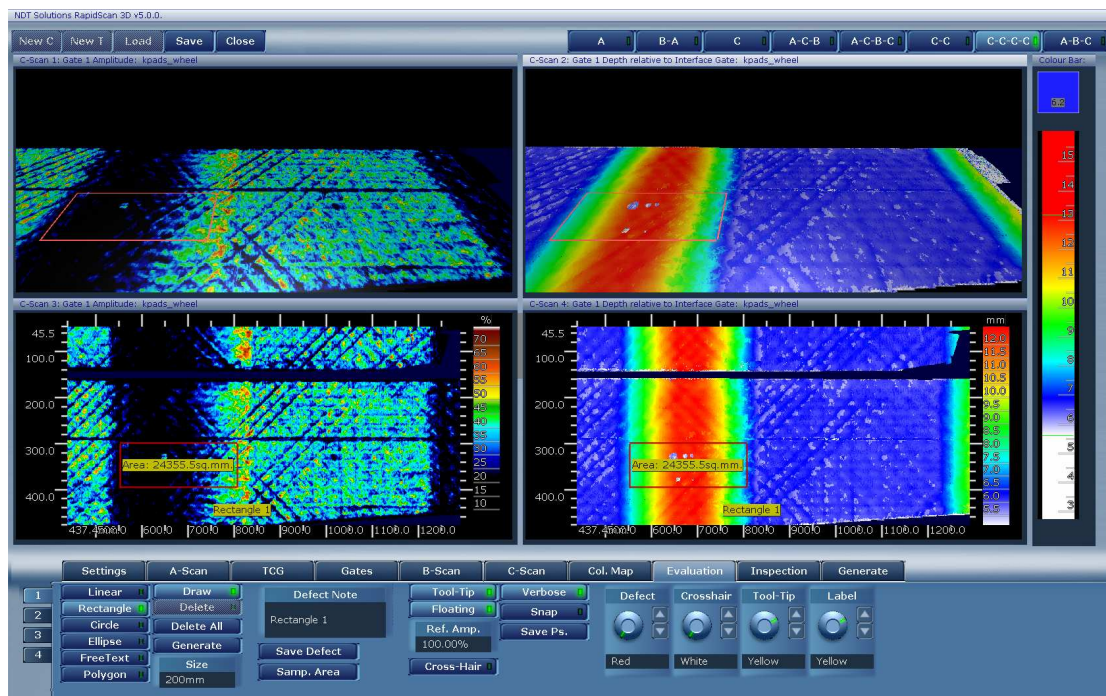
Double-clicking with the left mouse-button on a point on the 2D view of a C-scan will set the 3D view to inspect this area. This is the same behaviour as if the same point on the 3D view was double-clicked.

The evaluation shape tools can also be used directly on the 3D view using the same mouse gestures as for the standard 2-dimensional C-scan evaluation. Therefore, distances and areas can be measured quickly and easily in 3-dimensions.



**Figure 109: Linear Defect Shape Primitive in 3 and 2-Dimensions**

Figure 109 shows a demonstration of the linear defect shape primitive. The line was drawn by clicking on one of the 3D views but it appears on all four C-scan views.



**Figure 110: Rectangle Defect Shape Primitive in 3 and 2-Dimensions**

Figure 110 shows the rectangle defect shape primitive drawn on all four C-scan views. The shape was drawn by clicking and dragging the left mouse button on one of the 3D views.

### 7.9.2. Using the FaroArm

RapidScan 3D also provides a number of features for the evaluation of ultrasonic data using the FaroArm. This provides an even more intuitive method for evaluation of scan data as the arm is directly pointed at the physical region of interest rather than using an indirect visualisation in two or three dimensions. Each of the features described in section 7.9.1 also applies to the FaroArm as well as the mouse.

For accuracy, the 3mm ball probe is used rather than the ultrasonic tool used for collecting the data; this means that individual A-scans can be easily identified and accurate measurements using the defect shape primitives can be made. These functions are available in offline mode, either directly after a scan or at some point in time afterwards provided that a valid calibration of the part has been made if its position has changed.

The left and right mouse buttons are mapped to the green and red FaroArm buttons respectively. Individual A-scans can be selected by pointing the connected ball-probe at areas on the part and clicking or holding the green arm button. Defect shape primitives can be drawn using the arm by pointing the arm at the appropriate points on the part and clicking and holding the green arm button.

## **8. Worked Examples**

### **8.1. General Method**

This section of the manual aims to guide the user through a series of worked examples to demonstrate both effective use of the RapidScan for a variety of structures and to provide a guideline procedure for setting up the instrument for new inspections. The methodology presented should enable relatively inexperienced users to follow and adapt the examples to inspect a range of materials and structure. The RapidScan system is suited to be operated by strong level 2 / level 3 UT practitioners.

This section will deal only with the use of RapidScan for inspecting nominally flat components. Several other shapes and size of component have been inspected using RapidScan, including pipes, flanges and radii. Each of these requires a dedicated sensor and technique that are not currently general-purpose tools.

In order to set up the RapidScan for an inspection, it is always important to know information about the part that is to be tested and the typical defects to be located. This is the same information that is required for any A-scan inspection;

- What is the material?
- What is the structure geometry? (single piece? bonded components? parallel surfaces?)
- What is the thickness?
- What defects do I want to detect? (acceptance criteria)

From the above information we should be able to answer the following questions;

- What probe frequency do I use?
- What A-scan feature do I follow with the gates?
- What C-scan do I display?

Before starting any inspection, the array transducer should be normalised according the procedure in section 5.2.

### **8.2. Thickness Mapping (Corrosion)**

This example demonstrates the use of the RapidScan instrument for mapping out the thickness of a part. This is often performed for the detection and measurement of corrosion as well as verifying manufacturing tolerances.

- What is the material? **Mild Steel**



## 8 Worked Examples

---

- What is the structure geometry? **Single piece (parallel surfaces where not corroded)**
- What is the thickness? **Nominally 6.5mm**
- What defects do I want to detect? **Corrosion, wall loss of 12.5%, ~0.8mm**

From the above information, the A-scan can be set using a range of ~20mm (back wall echo + a multiple) using a velocity of 5960m/s. TCG should not be required.

- What probe frequency do I use? **5MHz - 10MHz (low attenuation material + requires good depth resolution)**
- What A-scan feature do I follow with the gates? **Interface gate set to follow the top surface, gate 1 largest peak starts relative to interface gate start 4mm width 5mm with low threshold (~5%), gate 2 largest peak starts relative to gate 1 start 4mm width 5mm with low threshold (~5%)**
- What C-scan do I display? **Time of flight gate 2 relative to gate 1**



Figure 111: A-scan showing gate set up

The instrument is now ready to record a C-scan. Specify the scan length, click Go and perform the scan. The colour map applied to the C-scan must be adjusted to suit the data range. The example shown is a 'Spectrum' colour map set from 2mm (red) to 8mm (blue). Two scanned areas are shown below, one without and one with corrosion. A second C-scan with a pass/fail (green/red) colour map applied at the acceptance threshold shows the corroded areas clearly.

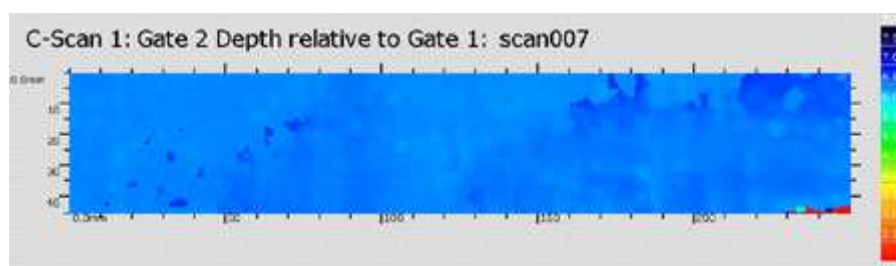


Figure 112: C-scan of area without corrosion

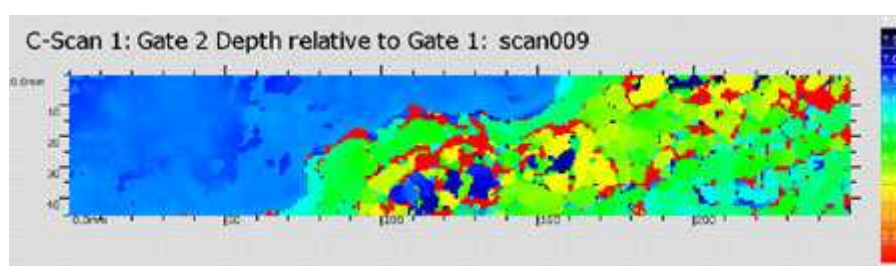


Figure 113: C-scan of area with corrosion

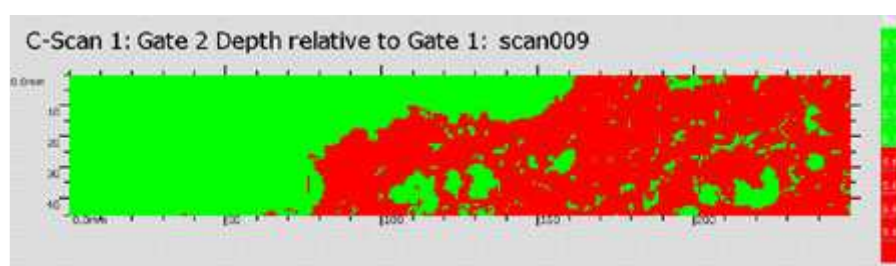


Figure 114: C-scan of area without corrosion with pass/fail colour map

### 8.3. Delamination Detection

This example demonstrates the use of the RapidScan instrument for inspecting composite parts for delaminations and large voids. The method employed is similar to that for corrosion mapping. The additional element to the inspection is that the A-scan and the gates should be set to achieve the best possible near surface resolution to inspect the full depth of the material. This is achieved by implementing TCG

- What is the material? **Carbon fibre composite**
- What is the structure geometry? **Single laminate**
- What is the thickness? **6mm**
- What defects do I want to detect? **Delaminations >5mm diameter**

## 8 Worked Examples

---

From the above information, the A-scan can be set using a range of ~12mm (single back wall echo) having calibrated the velocity, in this case 3075m/s.

- What probe frequency do I use? **5MHz (can be attenuative material + requires reasonable depth resolution)**
- What A-scan feature do I follow with the gates? **Interface gate set to follow the top surface, gate 1 largest peak starts relative to interface gate start 0.5mm (or as near as possible) width 7mm with low threshold (~5%)**
- What C-scan do I display? **Time of flight gate 1 relative to interface gate**

Apply logarithmic TCG such that the front face echo and the back face echo are of similar amplitude.

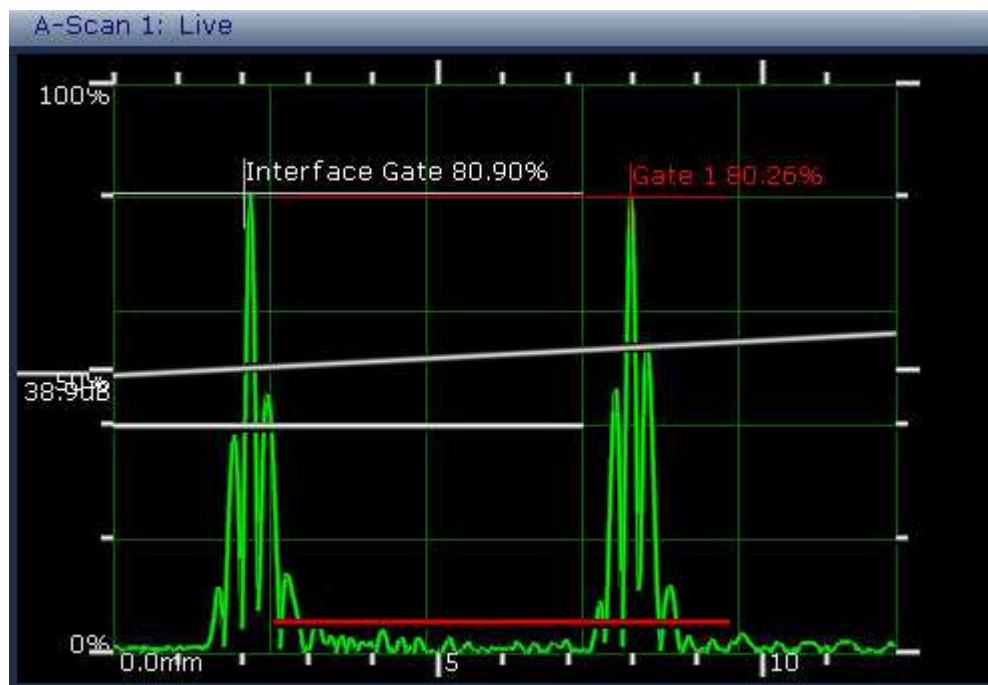


Figure 115: A-scan showing gate set up

The instrument is now ready to record the C-scan. Specify the scan length, click Go and perform the scan. The colour map applied to the C-scan must be adjusted to suit the data range. The example shown is has a 'Spectrum' colour map set from 0mm (red) to 7mm (blue). A C-scan over a range of artificial delaminations is shown below.

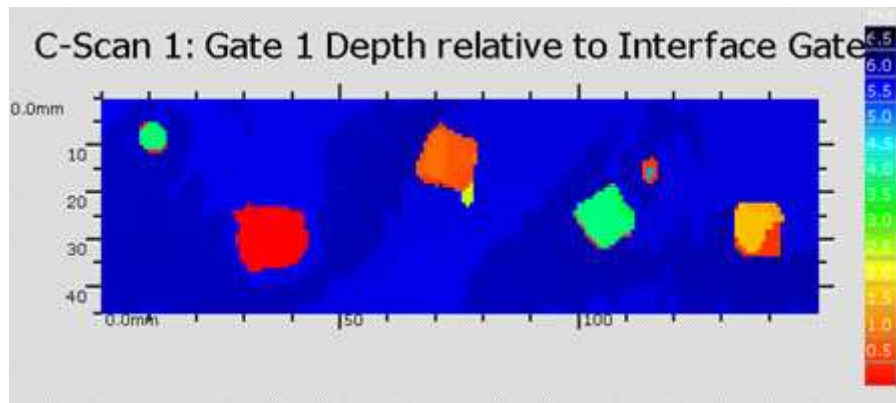


Figure 116: C-scan of six delaminations

The depth of each defect is indicated by its colour, demonstrating both the near surface and far surface capabilities for the inspection. A typical A-scan from a near surface defect is shown below. The defect was recorded as being 0.70mm below the top surface.



Figure 117: A-scan from a near surface defect (0.7mm depth)

To review the C-scan values, the current value and location is displayed either in the tool tip or in the C-scan top margin. The zoom-in square in the evaluation menu and/or colour bar is also a useful analysis tool to use at this stage too. This can help to show the user exactly which pixel is currently selected to simplify reviewing. The defects can now be sized and reported using the wide range of evaluation tools available. Each defect is marked up



and a range of information relating to that is available within the evaluation menu 2.

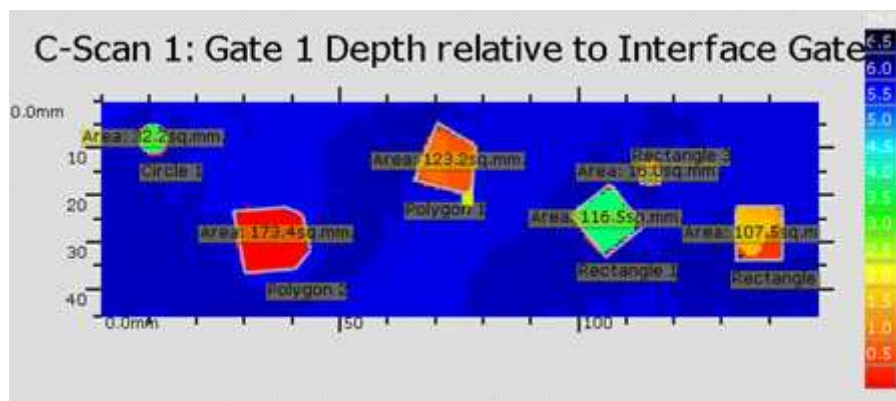


Figure 118: C-scan with all defects marked for evaluation

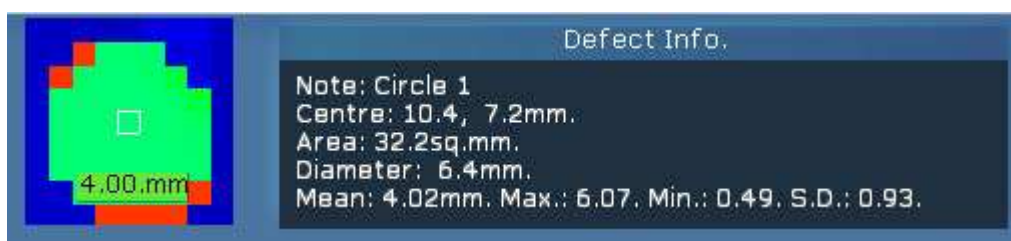


Figure 119: Defect information for Circle 1

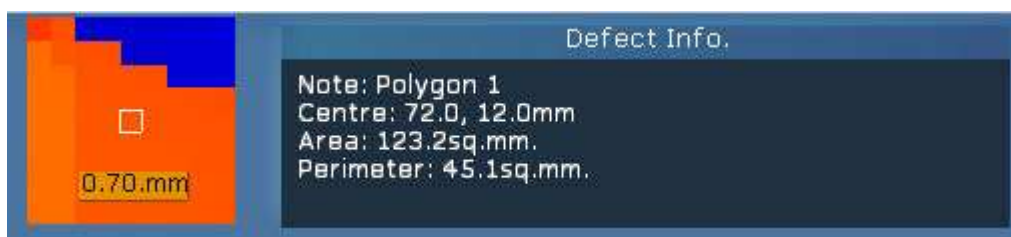


Figure 120: Defect information for Polygon 1

### 8.4. Porosity Inspection

This example demonstrates the use of the RapidScan instrument for inspecting composite parts for porosity and small voids. The most commonly employed method is based on monitoring signal amplitude although different companies use different models and acceptance criteria. The method followed here identifies small voids and foreign body inclusions by monitoring internal echoes as well as identifying micro-porosity by monitoring the amplitude of the

back wall echo. The A-scan and TCG should be set up in a similar manner to the delamination inspection in order to normalise the echo response. Ideally, a custom TCG curve should be implemented from a calibration sample manufactured from the same material as is to be inspected and containing several small (~2mm diameter) flat bottom holes at different depths.

- What is the material? **Carbon fibre composite**
- What is the structure geometry? **Single laminate**
- What is the thickness? **4-8mm**
- What defects do I want to detect? **Micro-porosity, small voids and foreign bodies**

From the above information, the A-scan can be set using a range of ~12mm (single back wall echo) having calibrated the velocity, in this case 2900m/s.

- What probe frequency do I use? **2MHz or 5MHz**
- What A-scan feature do I follow with the gates? **Interface gate set to follow the top surface, gate 1 largest peak starts relative to interface gate start 3.8mm (or as near as possible) width 5mm with low threshold (~5%),**
- What C-scan do I display? **Amplitude gate 1 absolute**

Perform a preliminary live scan over the panel with extrema activated. Identify an area with little or no porosity i.e. the area with the largest amplitude signal received from the back wall. Apply logarithmic TCG such that the front face echo and the back face echo are of similar amplitude. Adjust the Gain so that the back wall signal from a 'good' area is at 80% full screen height.

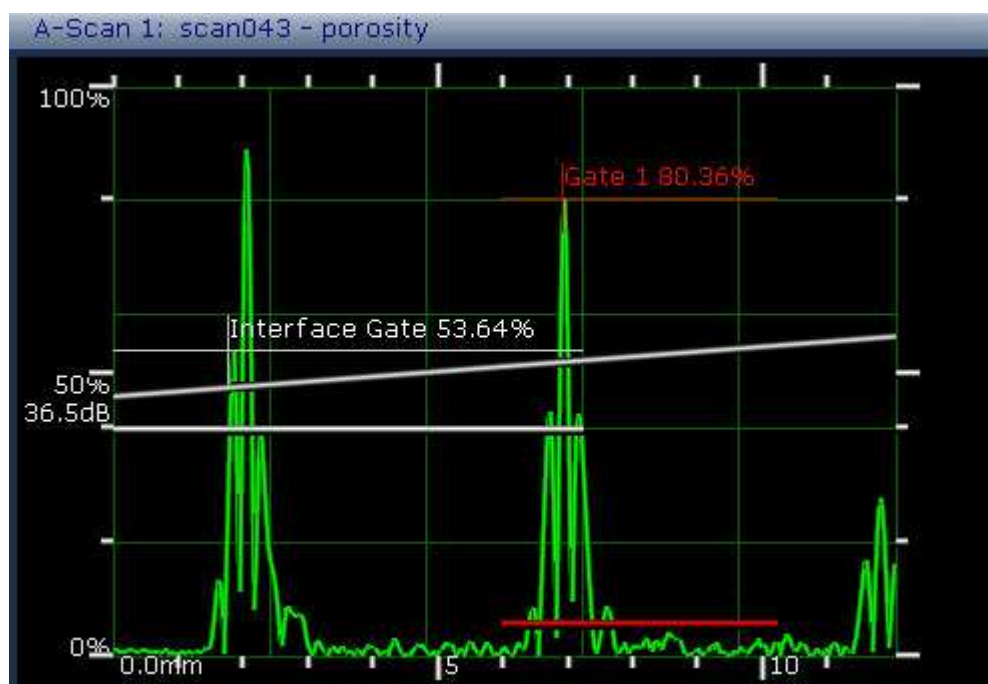
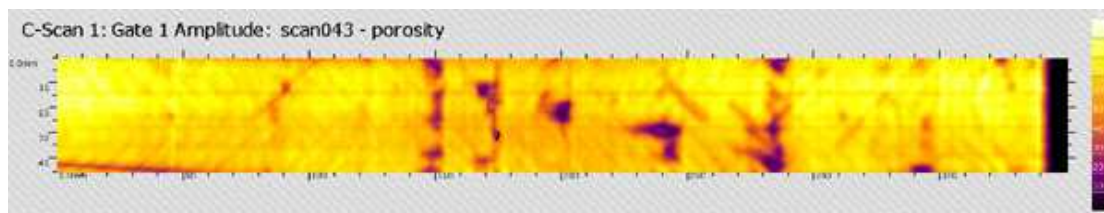


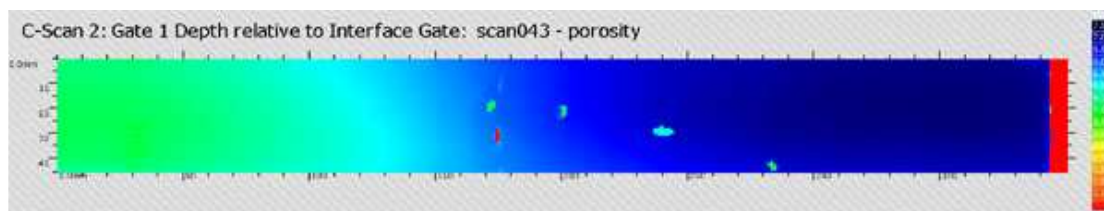
Figure 121: A-scan showing gate set up

The instrument is now ready to record the C-scan. Specify the scan length, click Go and perform the scan. The colour map applied to the C-scan must be adjusted to suit the data range. The example shown is has an 'Aerospace' colour map set from 0% (black) to 100% (white, through purple, orange, yellow). A C-scan showing the amplitude of the back wall signal is recorded.



**Figure 122: C-scan of amplitude of the back wall signal**

The C-scan produced is informative for detecting micro-porosity. The inspection additionally requires the user to monitor the internal structure for foreign bodies and layer porosity. An interesting feature about this sample is that the thickness varies through the depth of the structure, as shown in the C-scan below. The example shown is has a 'Spectrum' colour map set from 0mm (red) to 8mm (blue). Traditionally, thickness variation makes gating only on the internal echoes limited to the thinnest areas. However, this may be overcome by utilising variable width gates.



**Figure 123: C-scan of time of flight of the back wall signal**

In RapidScan, it is possible to reference the start position of a gate to another gate (such as the interface gate). It is also possible to reference the width of a gate to another (such as the back wall echo). The primary use of such a gate feature enables the user to set up a gate that maintains a position from just below the top surface to just above the bottom surface in an A-scan. This is ideal for monitoring for small internal flaws and impedance-matched foreign bodies (such as carbon-fibre release film). In addition to the above gate, the following details for gate 2 are added.

- What A-scan feature do I follow with the gates? **Gate 2 largest peak starts relative to interface gate start 1.0mm (or as near as possible) ends relative to gate1 end 0.5mm with low threshold**
- What C-scan do I display? **Amplitude gate 2 absolute**

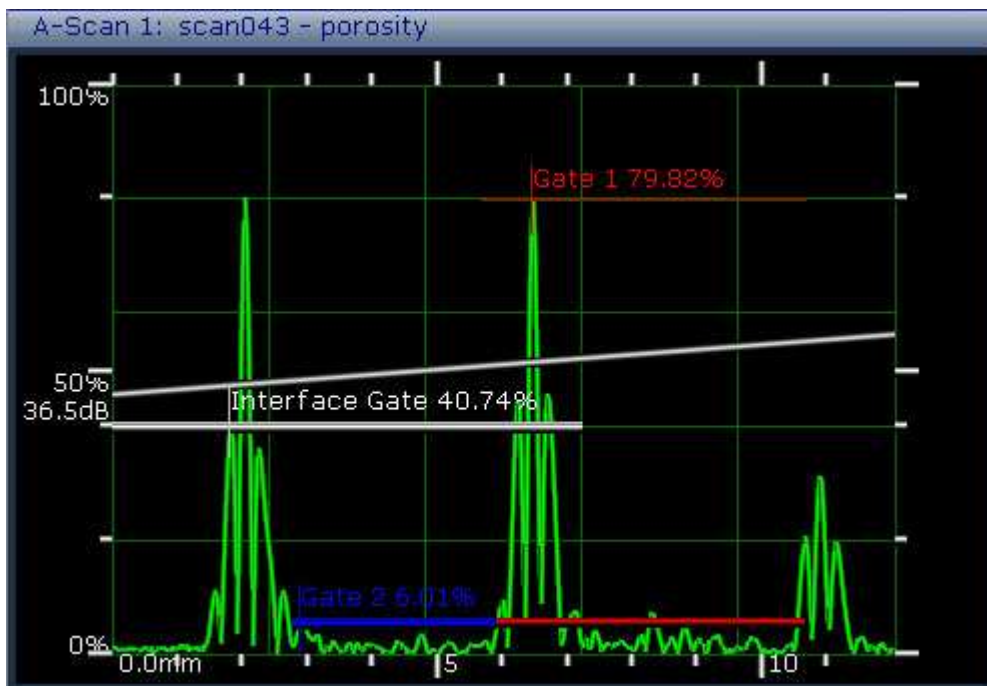


Figure 124: A-scan showing variable width gate set up

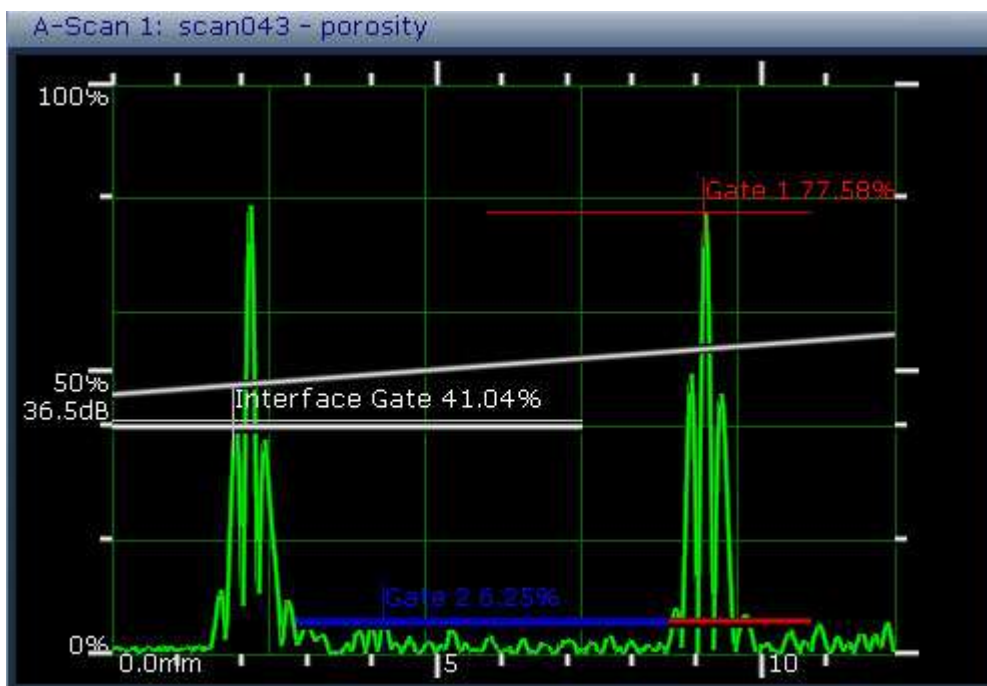


Figure 125: A-scan showing same gate set up on a thicker part of the structure

A C-scan of internal features is produced using gate 2, shown below displayed with the same colour map as C-scan 1; an 'Aerospace' colour map set from 0% (black) to 100% (white, through purple, orange, yellow).

## 8 Worked Examples

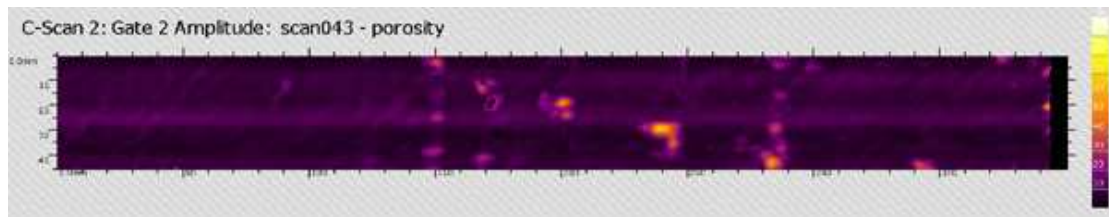


Figure 126: C-scan showing amplitude of internal flaws

To assist with data analysis it is possible to view multiple C-scans simultaneously using the view options in the top right of the screen. Using the C-C-A view the amplitude C-scans from gate 1 and gate 2 can be analysed together to differentiate between defect types. Areas where there is a low amplitude back-wall signal and no internal flaw signal are identified as areas of micro-porosity. The co-ordinates of the data and the measurement for the current point are displayed above each C-scan.

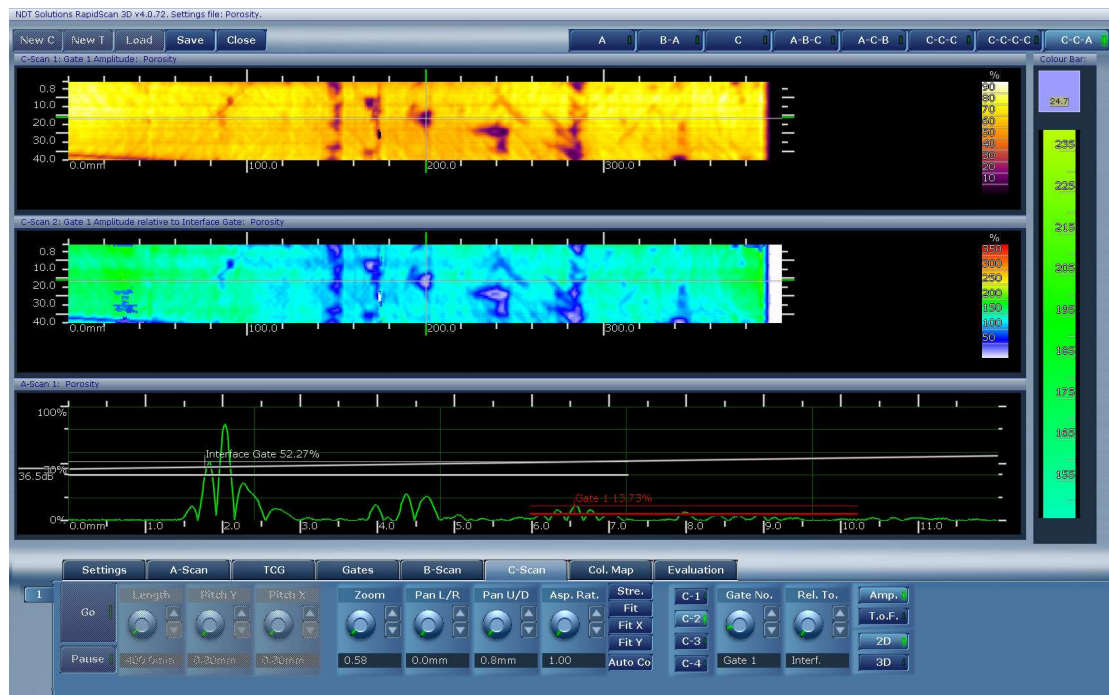
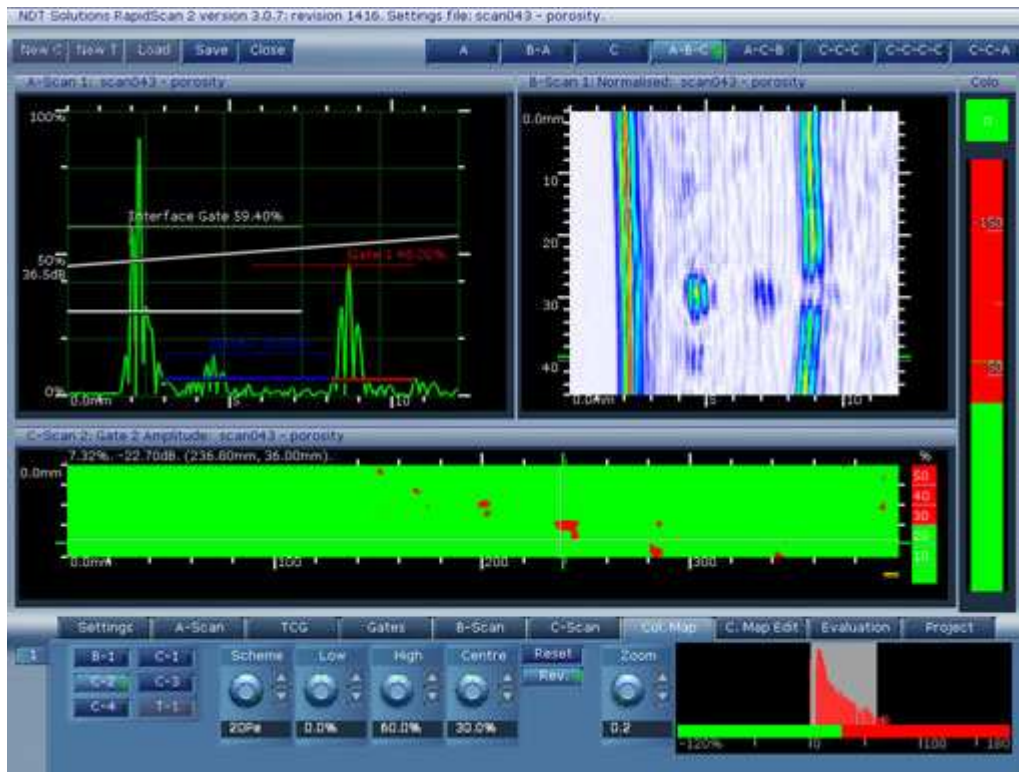


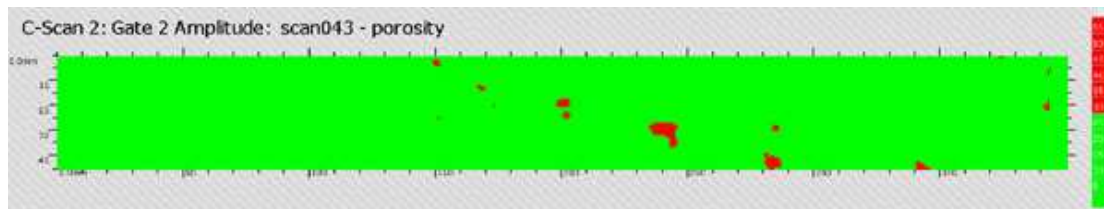
Figure 127: C-C-A view showing two simultaneous C-scans

Typical acceptance criteria are referenced in terms of dB level relative to a 'good' area of the structure. For this example, the internal flaws are defined as any signal occurring between the front face and back wall signals that is > 9dB below the amplitude of the back wall signal from the reference area, i.e. the 'good' area. As stated above in the procedure, the A-scan gain was set such that this signal gave 80% FSH. Therefore, the 9dB drop level can be approximated to be 30% FSH. The C-scan for the internal flaws (absolute amplitude of gate 2) was reprocessed as a pass / fail C-scan with the acceptance threshold of 30% FSH.



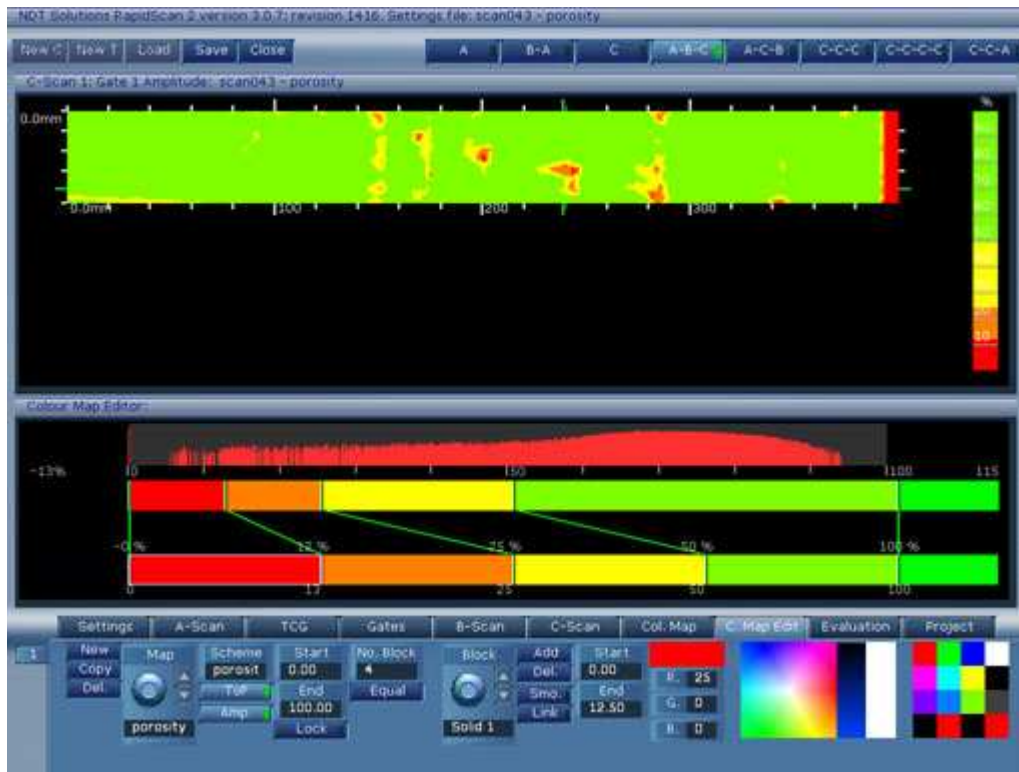


**Figure 128: A-B-C view showing evaluation of internal flaws**



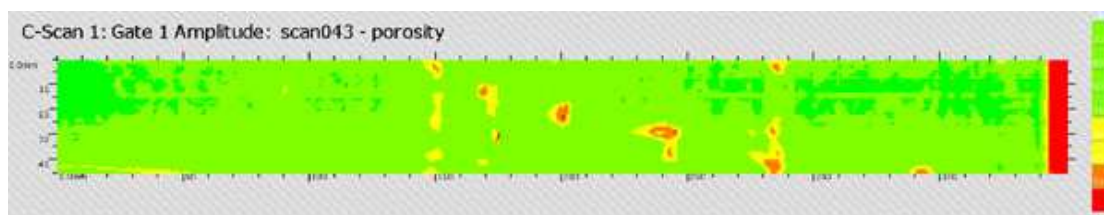
**Figure 129: C-scan of internal flaws with pass / fail colour map**

The other acceptance criteria, associated with loss of amplitude of the back wall, categorises the porosity according to its severity. For this a new colour map was created using the colour map editor. The porosity is split into several 'bins', 0 – 6dB loss, 6 – 12dB loss, 12 – 18dB loss, and >18dB loss. A new colour map was created and the scheme renamed to 'porosity'. The map contained 4 blocks. They were coloured as follows, under-range = black, block 1 = red, block 2 = orange, block 3 = yellow, block 4 = light green, over-range = green. The limits were set such that block 4 = 50% - 100% (0 – 6dB loss); block 3 = 25% - 50% (6 – 12dB loss); block 2 = 12.5% - 25% (12 – 18dB loss); block 1 = 0% - 12.5% (>18dB loss).



**Figure 130: C-scan and setting up a new colour map**

Using the new colour map the upper limit can be easily scaled by adjusting the high level of the colour map. So long as the low level remains on 0% then the proportionality of the colour bins will be preserved and the relative dB levels correct. The high level was adjusted to 80% in accordance with the scan and the following C-scan produced showing the amplitude of the back wall signal.



**Figure 131: C-scan showing applied logarithmic colour map**

The analysis of the porosity continues into sizing the defects in a similar manner to that shown above for the delamination inspection. A range of acceptance criteria may be appropriate depending upon factors such as the structural importance of the part, the part thickness, the fibre lay up, the resin used, etc.



### **8.5. Bond Inspection**

This example demonstrates the use of the RapidScan instrument for inspecting the bond line between composite parts for delaminations and large voids. The method described is applicable for the bond inspection of parts where the signals from the bond line and the back wall are easily identified and distinguished. This is normally not the case when inspecting thin metal components where frequently only the bond line echo can be identified and the back wall is masked by multiple reflections. In this case only the first part of the following method is valid.

- What is the material? **Carbon fibre composite**
- What is the structure geometry? **Bonded laminates**
- What is the thickness? **Each laminate ~3mm, combined thickness ~7mm**
- What defects do I want to detect? **Disbonds >10mm diameter**

From the above information, the A-scan can be set using a range of ~12mm (single back wall echo) having calibrated the velocity, in this case 3200m/s.

- What probe frequency do I use? **5MHz (for high quality laminate)**
- What A-scan feature do I follow with the gates? **Interface gate set to follow the top surface, gate 1 largest peak starts relative to interface gate start 1mm width 3mm with low threshold (~5%), gate 2 largest peak starts relative to interface gate start 4mm width 3mm with low threshold (~5%)**
- What C-scan do I display? **Amplitude gate 1 absolute, amplitude gate 2 absolute, amplitude gate 1 relative to gate 2**

In this case the A-scan display has been set to negative half wave in order to make the signals clearer. When the material is well bonded (good bond), then there is a strong reflection from the back wall of the material and only a small (if any) reflection from the bond line. As the percentage area that is bonded beneath the transducer reduces (partial bond) so the amplitude of the signal from the bond line increases and the amplitude of the back wall signal begins to reduce. When there is no bond beneath the transducer then only a signal is received from the bond line (disbond).

The gates have been set such that gate 1 tracks the bond line signal and gate 2 tracks the back wall signal. Bond assessment can be performed by monitoring either of these echoes. For increased accuracy, bond assessment can be performed by observing how the amplitude of one signal varies relative to the other signal, providing a robust inspection solution that is independent of coupling variations.

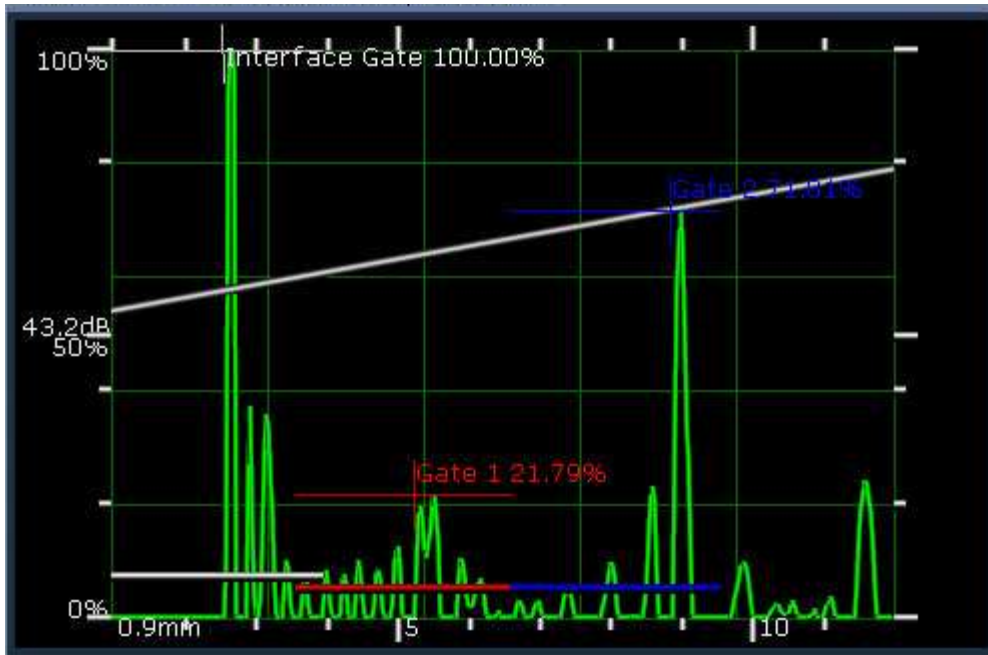


Figure 132: A-scan of a good bond

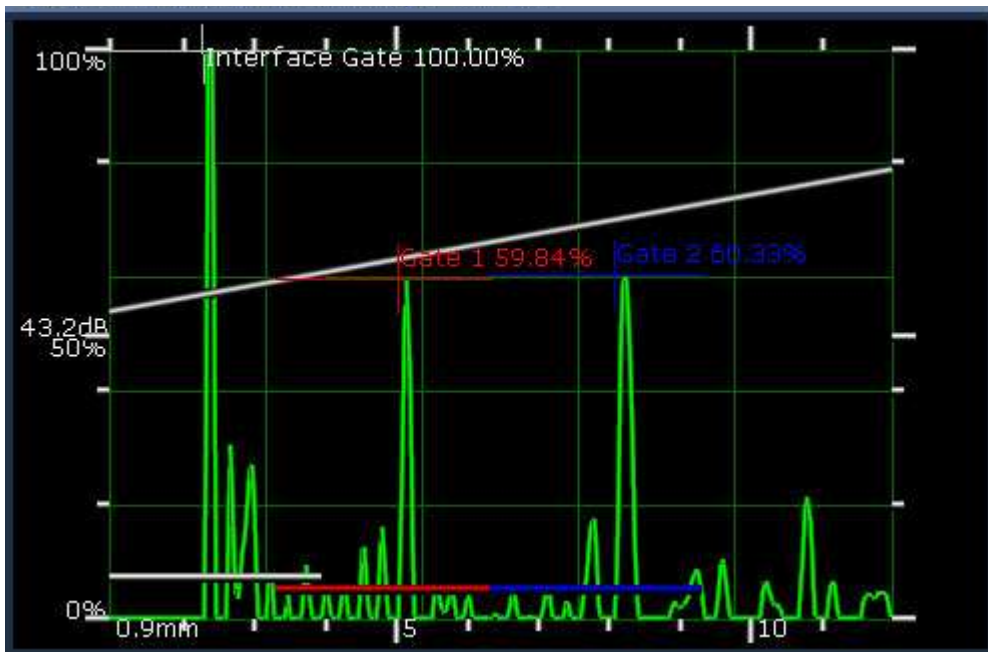


Figure 133: A-scan of a partial bond

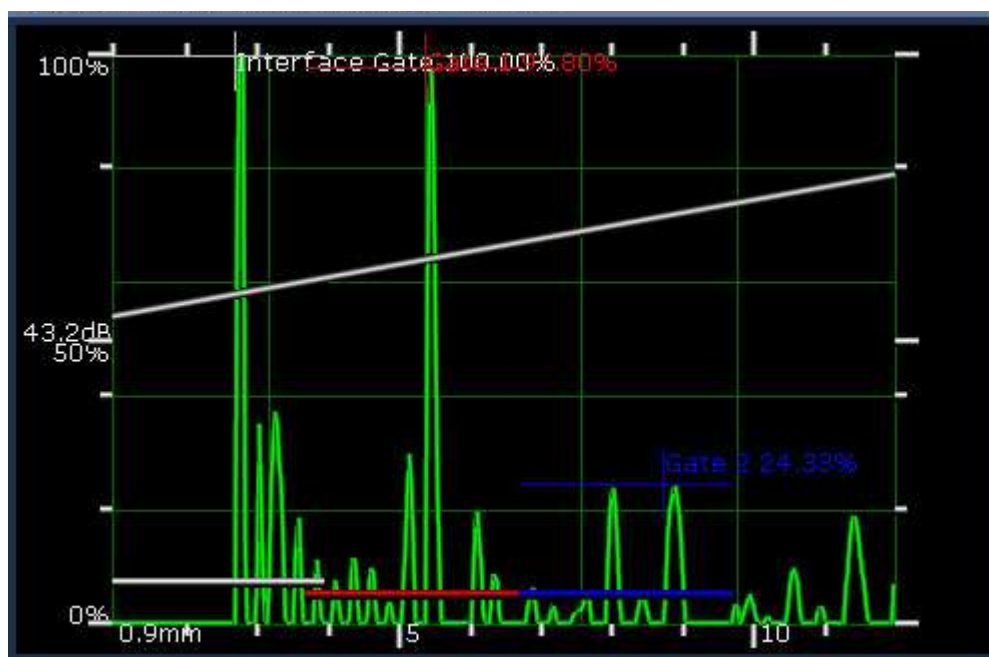


Figure 134: A-scan of a disbond

The instrument is now ready to record the C-scan. Specify the scan length, click Go and perform the scan. The colour map applied to the C-scan must be adjusted to suit the data range. The example shown is an 'Aerospace' colour map set from 0% (black) to 100% (white, through purple, orange, yellow).

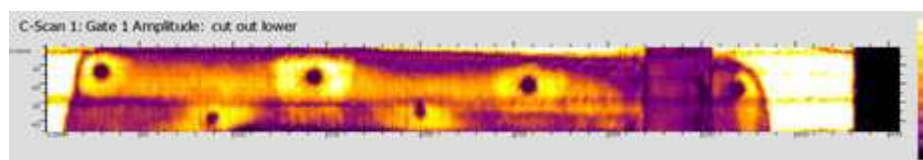


Figure 135: C-scan of the amplitude of the bond line signal

For this example, four scans were recorded around the outside of a cut out area. The scans covered the cut out edges to monitor for disbonds occurring at the locations where rivet holes had been drilled. The individual C-scans can be easily added, moved and rotated within the T-scan in order to re-assemble the full image. Overlap areas can be blended using the highest amplitude data for each point or just set so that one over-writes the other. The C-scans can be imported either with or without A-scan data depending on the required assessment. Once imported, full waveform data may be re-gated, regenerating the T-scan, to optimise the settings and to ensure the full data range is encompassed. Similar to the C-scan, the T-scan data (such as absolute amplitude, time of flight data, etc.) may be toggled to obtain multiple scan types as well as altering the colour maps. The origin for all the measurements may be set to anywhere on the scan by moving the cursor to the desired position and pressing the space bar. This is particularly useful for

## 8 Worked Examples

measuring the location of defects relative to a known position. In the example below, the T-scan is referenced to the centre of the top left rivet.

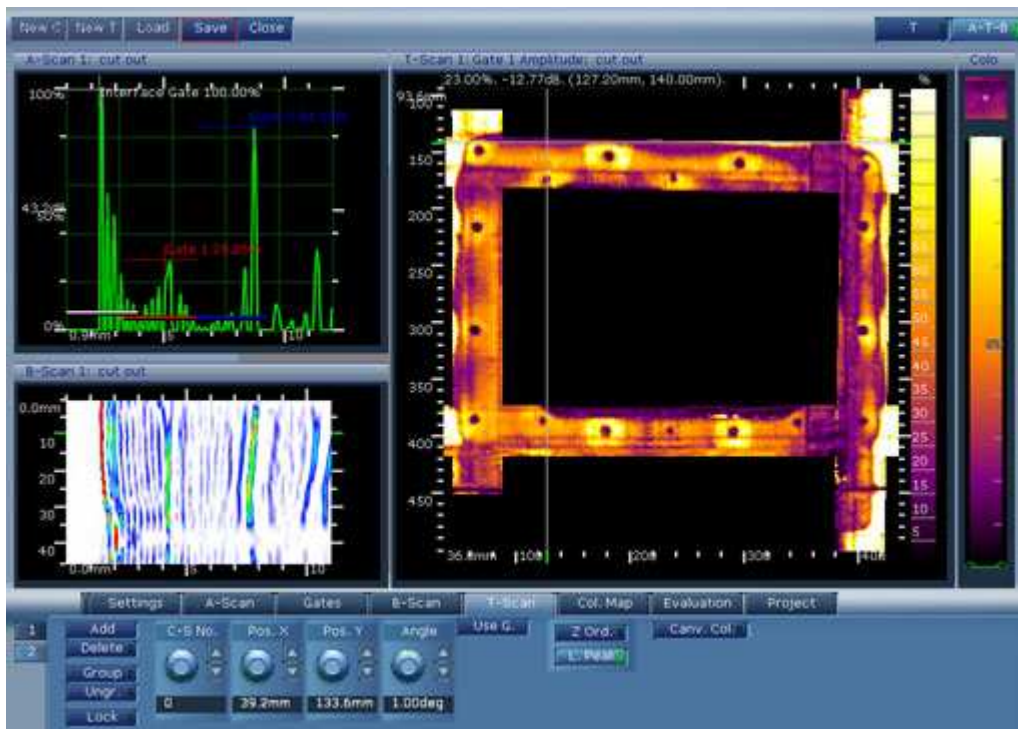


Figure 136: T-scan of the amplitude of the bond line signal

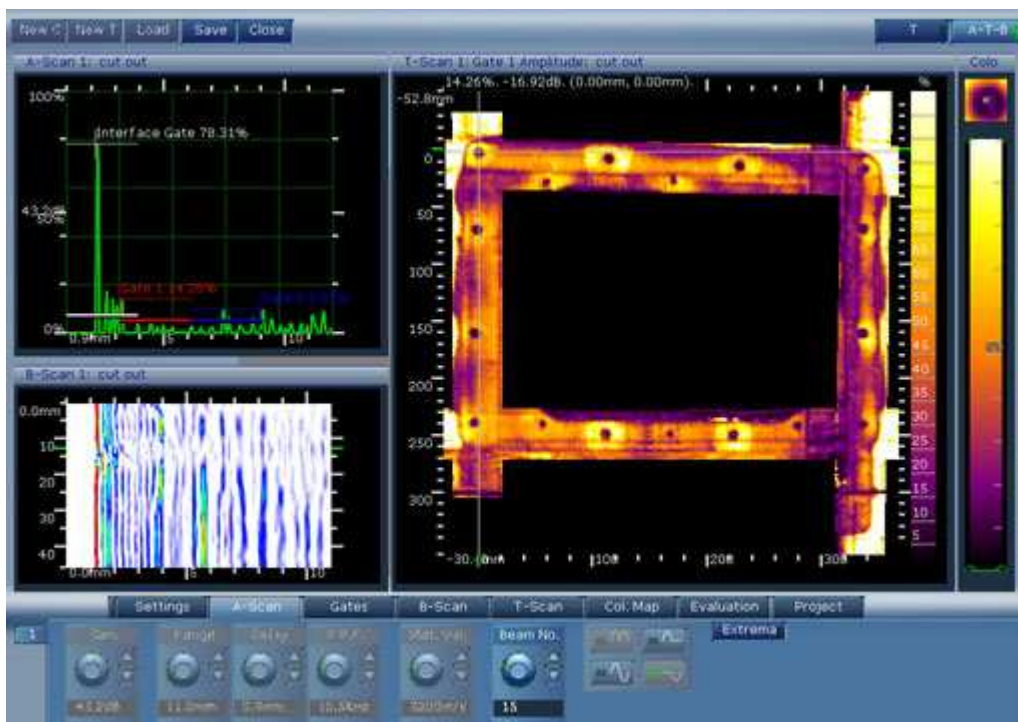
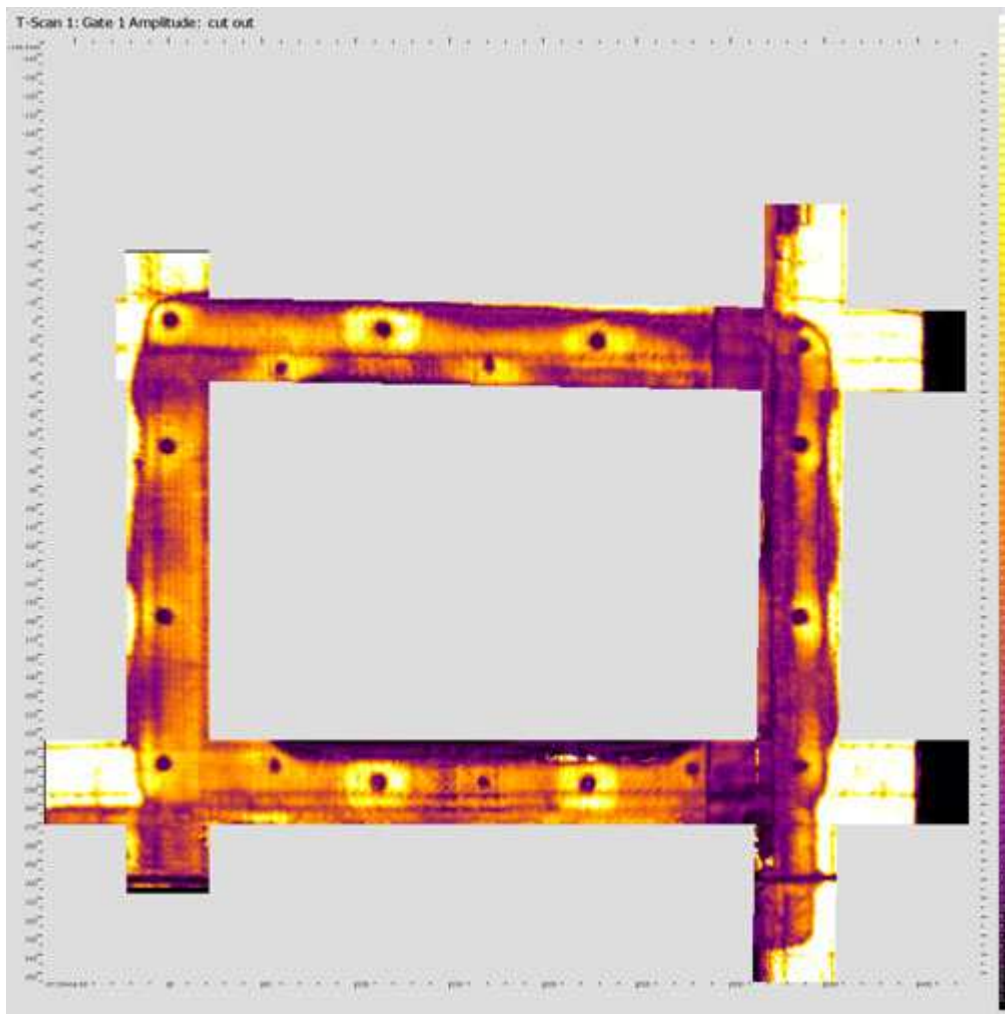


Figure 137: Same T-scan with the origin moved to the top left rivet

## 8 Worked Examples

---

As stated above, three T-scans can be used for the assessment, absolute amplitude of the bond-line signal, absolute amplitude of the back wall signal, amplitude of bond line signal relative to amplitude of back wall signal. All three were easily selected from the T-scan menu. The same 'Aerospace' colour map was applied to all the T-scans; the former two set from 0% (black) to 100% (white, through purple, orange, yellow), the latter set from 25% (black) to 400% (white, through purple, orange, yellow).



**Figure 138: T-scan of amplitude of bond line signal**



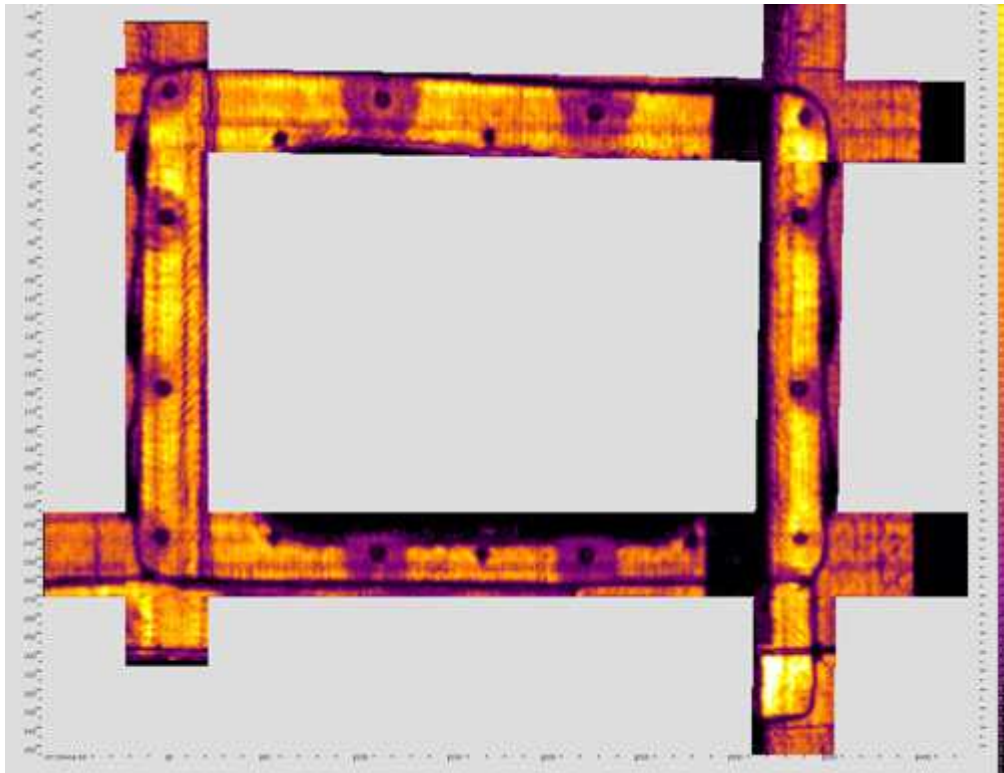


Figure 139: T-scan of amplitude of back wall signal

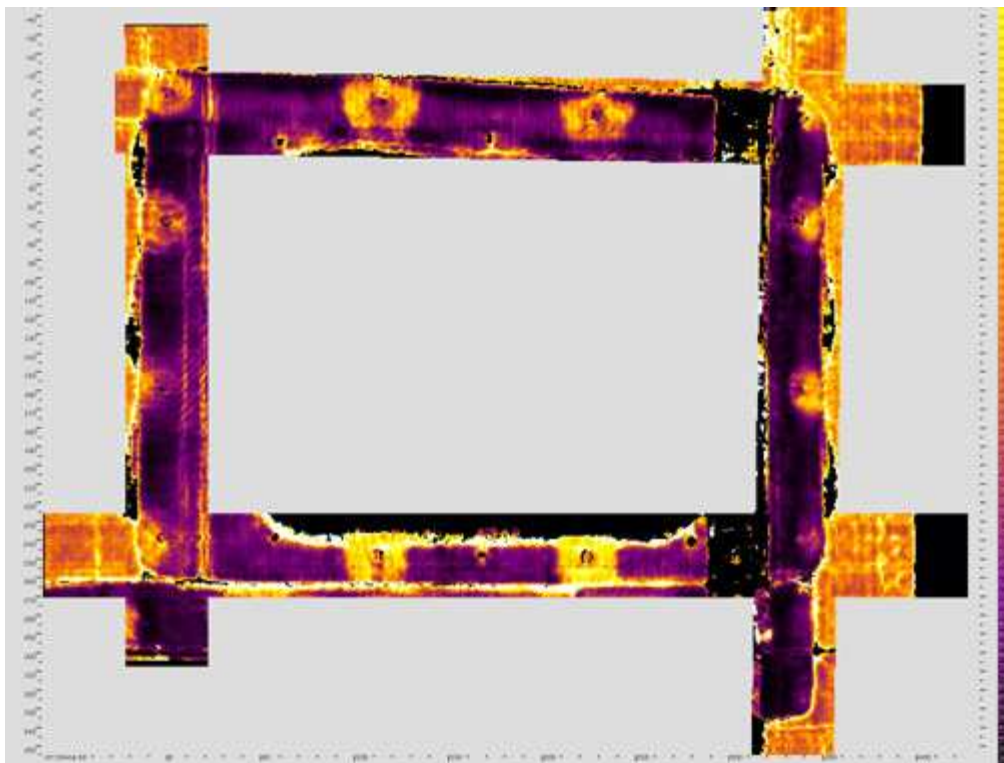


Figure 140: T-scan of amplitude of bond line signal relative to back wall signal

## 9. Keyboard and Mouse Shortcuts

### 9.1. Keyboard Shortcuts

Key	Description
<b>F1</b>	Show the help dialog
<b>F2</b>	Go Online / offline
<b>F3</b>	A-Scan View
<b>F4</b>	C-Scan View
<b>F5</b>	Mixed View
<b>F6</b>	Colour Map
<b>F7</b>	Gates
<b>F8</b>	Quick save settings
<b>F9</b>	Freeze real-time displays
<b>F11</b>	Increase gain
<b>Shift-F11</b>	Decrease gain
<b>F12</b>	Start scan
<b>Ctrl-I</b>	Save selected C or T-scan image as bitmap
<b>Ctrl-Shift-I</b>	Save selected C or T-scan image as bitmap without border
<b>Ctrl-P</b>	Print focus C or T-scan image

### 9.2. Mouse Shortcuts for C or T-Scan

Mouse Action	Description
Shift + left mouse drag on scan	Select A and B-scans
Right mouse drag on scan	Select A and B-scans
Left drag on background	Pan scan
Mouse wheel	Zoom scan about mouse position

### 9.3. Keyboard Shortcuts for T-Scan Only

Key	Description
<b>0 to 9</b>	Select C-scan
<b>Cursors</b>	Move selected C-scan
<b>Ctrl-Cursors</b>	Rotate selected C-scan
<b>a</b>	Add new C-scan
<b>d, DEL</b>	Delete current C-scan

### 9.4. Mouse Shortcuts for T-Scan Only

Mouse Action	Description
Left drag on C-scan	Move C-scan



## 9 Keyboard and Mouse Shortcuts

---

Ctrl + left drag on C-scan	Rotate C-scan
Sh. + left drag on C-scan	C-scan transparency
Double right click on C-scan	Switch T-scan and A-T-B views

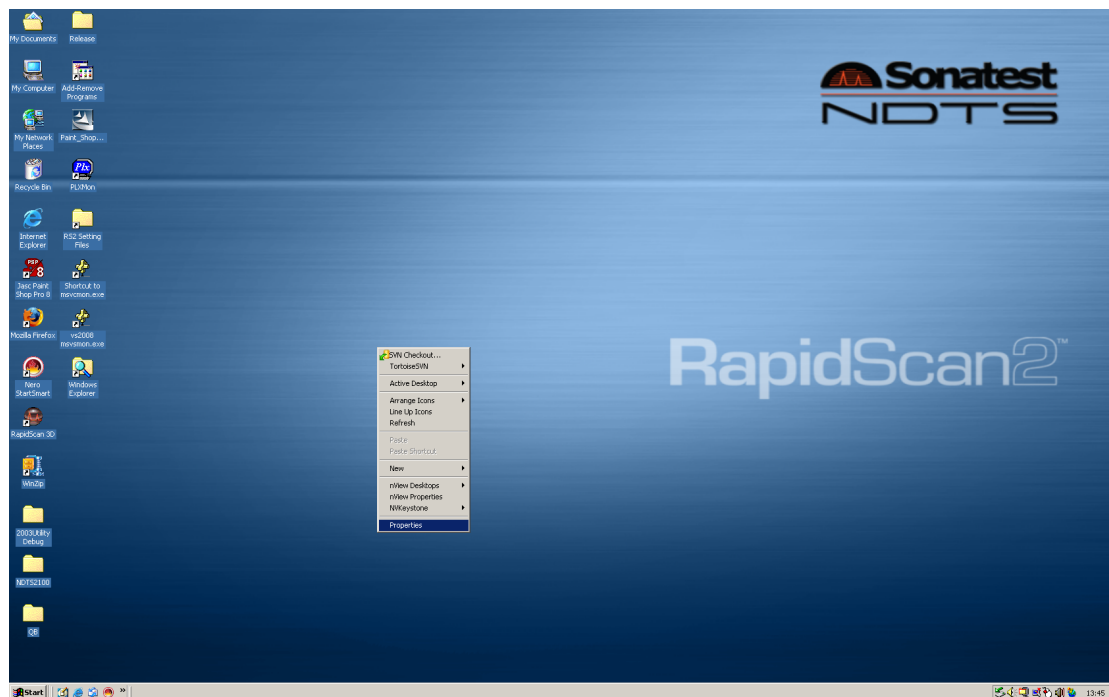
## Appendices

### **HUD Glasses/External Monitor Support**

The secondary display support provided in RapidScan is only available for licences which include this feature.

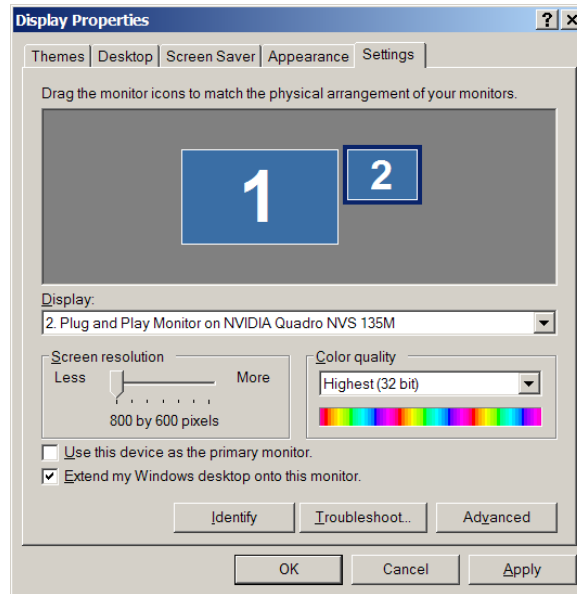
### **Activating Secondary Display**

- a. Physically attach the HUD display glasses or secondary monitor to the RapidScan system using the secondary display input.



**Figure 141: Display Properties choice**

- b. Right-click on desktop and select **Properties**, as shown in Figure 108.



**Figure 142: Display Properties Settings tab**

- c. Select the **settings** tab, see Figure 109.
  - i. Click on the rectangle labelled 2.
  - ii. Select **Extend my Windows desktop onto this monitor**.
  - iii. Choose the appropriate resolution for the secondary display using the **screen resolution** slider; this will usually be 800x600 for HUD glasses but it may be considerably higher for an external monitor. The secondary display should always be used at its native resolution; please see the user-guide for the device for further details.
- d. Assuming the correct licence is available, RapidScan is now set-up to use the external display.

### Using Secondary Display

A number of different view layouts can be selected on the external display in the same way for the primary display (see section 5.6.1, page 57.) The scan view layout shown on the secondary display matches the primary but is scaled to the appropriate resolution. Currently, there is no support for mouse gestures on the secondary display and the usual dialog containing controls at the bottom of the screen is removed for this view. See Figure 110 and 111, these show the corresponding renderings at different resolutions on the two displays.

Widescreen (8/5) and normal (4/3) resolutions can be mixed for both the primary and secondary displays.

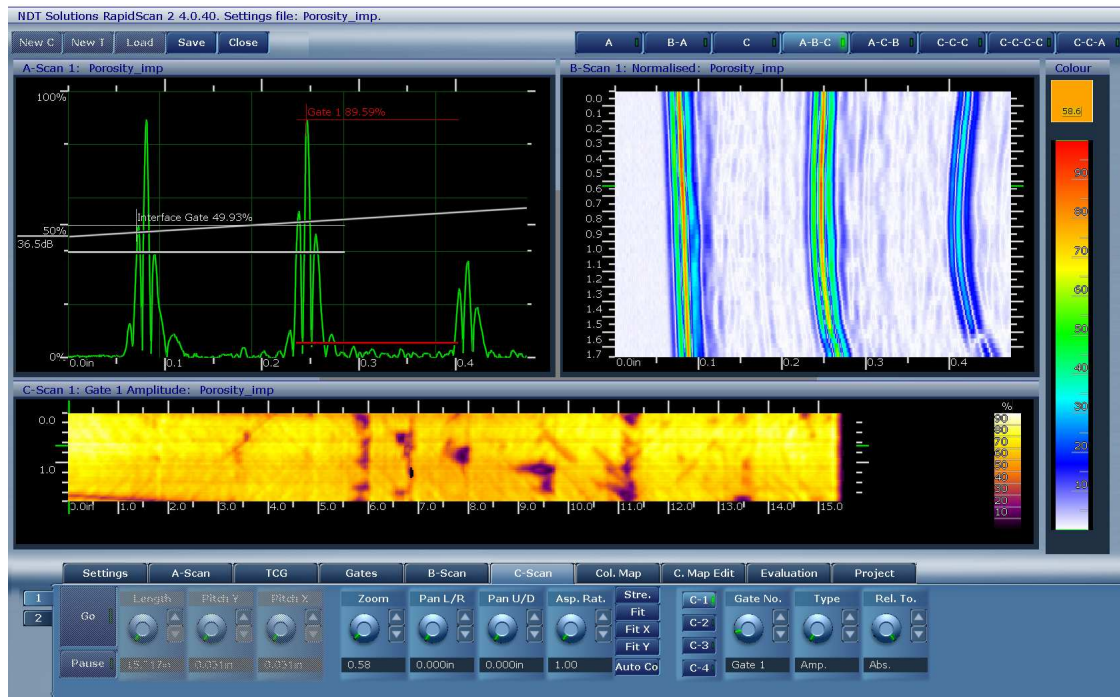


Figure 143: Primary display at 1680x1050 pixels

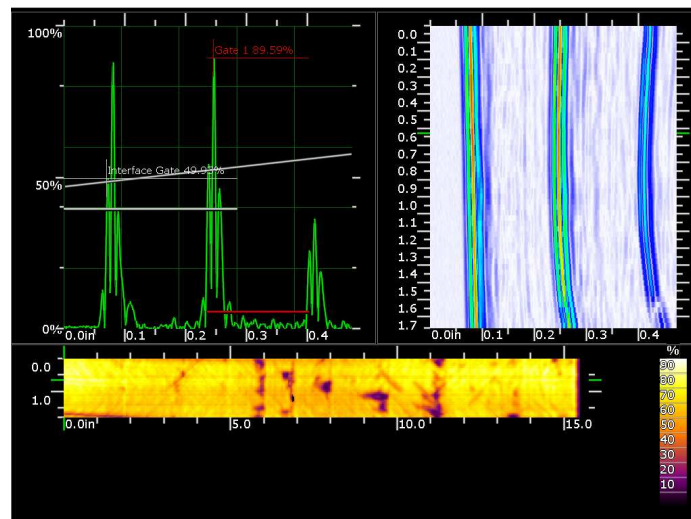


Figure 144: Secondary display at 1024x768 pixels

### Deactivating Secondary Display

- Navigate to the Settings tab of the Display properties, as in section of Figure 109 shows.
- Deselect **Extend my Windows desktop onto this monitor**.